



SEADOO®



Operator's Guide

Includes
Safety, Vehicle and
Maintenance Information

2006

4-TEC™ SERIES



WARNING

Read this guide thoroughly. It contains important safety information.

Do not remove this Operator's Guide from the vehicle.

2 1 9 0 0 0 4 0 5

This Operator's Guide utilizes the following symbols to emphasize particular information:

 The Safety Alert Symbol indicates a potential personal injury hazard.

 **WARNING** Indicates a potentially hazardous situation which, if not avoided, could result in serious injury or death.

CAUTION: Denotes an instruction which, if not followed, could severely damage vehicle components.

NOTE: Indicates supplementary information needed to fully complete an instruction.

 **WARNING**

For your safety, understand and follow all the safety precautions and instructions contained in this Operator's Guide, the Safety Video and the on-product labels. **Failure to do so can result in SEVERE INJURY OR DEATH.**

The watercraft operator has the responsibility to inform passenger(s) of safety measures.

Keep this Operator's Guide in a waterproof bag with the vehicle at all times. This Operator's Guide and the Safety Video should remain with the vehicle at the time of sale.



Knight's Spray-Nine[†] is a trademark of Korkay System Ltd
GTX[†] is a trademark of Castrol Ltd. Used under license

This is a non-exhaustive list of trademarks that are the property of Bombardier Recreational Products Inc. or its affiliates:

XP-STM mineral injection oil	DESSTM	SEA-DOO®
XP-STM synthetic 2-stroke oil	GTITM	Sea-Doo LK™
XP-STM 10W-40 4-stroke oil	O.P.A.S.™	XP®
Sea-Doo® synthetic grease	Rotax®	4-TECTM
	RXP™	

Printed in Canada. (smo2006-002 DR)
®™ and the BRP logo are trademarks of Bombardier Recreational Products Inc. or its affiliates.
©2005 Bombardier Recreational Products Inc. and BRP US Inc. All rights reserved.
* Trademark of Bombardier Inc. used under license.

FOREWORD

The Operator's Guide has been prepared to acquaint the owner/operator or passenger with this personal watercraft and its various controls, maintenance and safe riding instructions. It is indispensable for the proper use of the product and should be kept in a waterproof bag with the watercraft at all times.

Make sure you read and understand the content of the Operator's Guide.

For any questions pertaining to the warranty and its application, consult the WARRANTY section in this guide, and/or an authorized Sea-Doo dealer.

In USA, products are distributed by BRP US Inc. In Canada, products are distributed by Bombardier Recreational Products Inc. (collectively "BRP").

The information and components/system descriptions contained in this guide are correct at the time of writing. BRP however, maintains a policy of continuous improvement of its products without imposing upon itself any obligation to install them on products previously manufactured.

Because of its ongoing commitment to product quality and innovation, BRP reserves the right at any time to discontinue or change specifications, designs, features, models or equipment without incurring obligation.

The illustrations in this document show the typical construction of the different assemblies and may not represent the full detail or exact shape of the parts. However, they represent parts that have the same or similar function.

It is understood that this guide may be translated into another language. In the event of any discrepancy, the English version shall prevail.

Specifications are given in the SI metric system with the SAE U.S. equivalent in parenthesis. Where precise accuracy is not required, some conversions are rounded off for easier use.

A Shop Manual can be obtained for complete service, maintenance and more repair information.

The use of LEFT (port) and RIGHT (starboard) indications in the text, always refers to driving position (when sitting on watercraft).

Furthermore, in the marine industry, FRONT is referred to BOW and REAR as STERN.

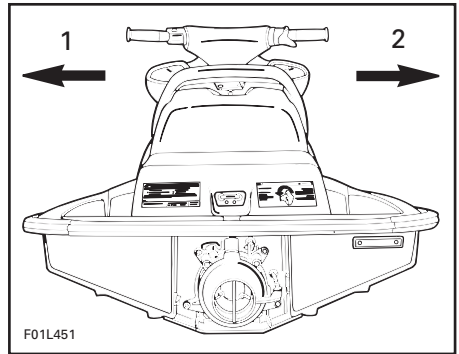

- 1. Left (port)
- 2. Right (starboard)

TABLE OF CONTENTS

SAFETY INFORMATION

INTRODUCTION	8
SAFETY CHECK LIST	9
GETTING UNDERWAY	10
OPERATION	14
OPERATING RULES	17
WATERSKIING SIGNALS	18
WEB SITES	19
LOCATION OF THE IMPORTANT LABELS	21

VEHICLE INFORMATION

REGISTRATION NUMBER LOCATION	32
IDENTIFICATION NUMBERS	33
CONTROLS/INSTRUMENTS/EQUIPMENTS	34
CONTROLS/INSTRUMENTS/EQUIPMENTS FUNCTIONS	38
1) Safety Lanyard (engine cut-off cord)	38
2) Handlebar	39
3) Throttle Lever	40
4) Engine Start/Stop Button	40
5) Variable Trim System (VTS) Button (if so equipped)	40
6) Shift Lever	41
7) Information Center Gauge	42
8) Glove Box	44
9) GPS Receiver (Global Positioning System) (if so equipped)	44
10) Fuel Tank Cap	45
11) Front Storage Compartment Cover	46
12) Front Storage Compartment Cover Latch	47
13) Tool Kit	47
14) Air Intake Opening	48
15) Seat Strap	48
16) Seat Extension Latch (if so equipped)	48
17) Seat Latch	48
18) Seat Cover (if so equipped)	49
19) Rear Grab Handle	49
20) Rear Storage Basket (if so equipped)	50
21) Front and Rear (bow/stern) Eyelets	50
22) Mooring Cleats	51
23) Footboard	51
24) Boarding Pads	51

25) Boarding Platform	51
26) Boarding Step (if so equipped)	51
27) Flushing Connector	52
28) Bilge Drain Plugs	53
29) Jet Pump Nozzle	53
30) Reverse Gate	54
31) Jet Pump Water Intake and Ride Plate	54
32) Fuses	54
33) Battery	55
34) Side Vanes	55
35) Engine Oil Dipstick	56
36) Engine Oil Filling Cap	56
37) Cooling System Expansion Tank Cap	57
38) Ski/Wakeboard Post (if so equipped)	57
39) Wakeboard Rack (if so equipped)	58
LIQUIDS	61
Fueling Procedure	61
Recommended Fuel	61
Engine Oil	62
Engine Coolant	64
BREAK-IN PERIOD	66
PRE-OPERATION CHECKS	67
Hull	68
Jet Pump Water Intake	68
Bilge	68
Battery	68
Fuel Tank	68
Engine Compartment	68
Engine Oil Level	68
Engine Coolant Level	68
Steering System	69
Throttle System	69
Shifter System	69
VTS (Variable Trim System) (if so equipped)	69
Storage Compartment Covers and Seat	69
Wakeboard Rack (if so equipped)	69
Safety Lanyard and Engine Start/Stop Button	70
Water Flow in Exhaust Manifold (only when temperature is below or close to freezing point)	70
OPERATING INSTRUCTIONS	71
Principle of Operation	71
Boarding the Watercraft	76
Starting	77
Riding	78
Operation with Wakeboard Rack	78
Rough Water or Poor Visibility Operation	79
Crossing Waves	79

Stopping/Docking	79
Beaching	79
Shutting Off the Engine	80
POST-OPERATION CARE.....	81
General Care	81
Additional Care for Foul Water or Salt Water	81
Exhaust Cooling System Flushing	81
Anticorrosion Treatment	83
SPECIAL PROCEDURES	84
Monitoring System	84
Engine Overheating.....	84
Engine Low Oil Pressure.....	84
Jet Pump Water Intake and Impeller Cleaning	85
Capsized Watercraft	85
Submerged Watercraft	86
Water-Flooded Engine.....	86
Fuel-Flooded Engine.....	86
Towing the Watercraft in Water.....	87
Low-Charge Battery Condition	88

MAINTENANCE INFORMATION

Engine Emissions Information.....	90
General.....	91
MAINTENANCE CHART	92
Periodic Inspection	92
MAINTENANCE.....	96
Lubrication	96
Throttle Cable Inspection	97
Engine Oil Change and Oil Filter Replacement	98
Valve Adjustment	98
Coolant Replacement	98
Fuel Injection System	98
Steering Alignment	98
VTS Adjustment (if so equipped).....	98
Bilge Drain Plugs.....	99
Fuses.....	99
Fuse Identification	101
O.P.A.S. System (if so equipped).....	103
Drive Shaft Corrosion Protection	103
Ski/Wakeboard Post (if so equipped)	103
General Inspection and Cleaning.....	103
TRAILERING, STORAGE AND PRESEASON PREPARATION	104
Trailering	104
Launching/Loading.....	105
Storage.....	105
Preseason Preparation	107

Preseason Preparation Chart	108
TROUBLESHOOTING	109
SPECIFICATIONS	118
ABBREVIATIONS USED IN THIS MANUAL	124

WARRANTY

BRP NORTH AMERICA LIMITED WARRANTY: 2006 SEA-DOO® PERSONAL WATERCRAFT.....	127
CALIFORNIA AND NEW YORK EMISSION CONTROL WARRANTY STATEMENT FOR MODEL-YEAR 2006 SEA-DOO® PERSONAL WATERCRAFT WITH 4-TEC™ ENGINES OR 4-TEC DT ENGINES OR 4-TEC SC ENGINES OR 4-TEC IC ENGINES	131
BRP INTERNATIONAL LIMITED WARRANTY: 2006 SEA-DOO® PERSONAL WATERCRAFT.....	135
DECLARATION CE OF CONFORMITY	138
PRIVACY INFORMATION.....	139

SAFETY INFORMATION

INTRODUCTION

Congratulations, you are now the proud owner of a Sea-Doo personal watercraft. You have selected one of the most popular watercraft on water. Your Sea-Doo® personal watercraft (PWC) can provide you and your family or friends the opportunity to fully enjoy the natural beauty and excitement of the world's waterways. Welcome to fun on water!

With this new enjoyment and freedom however comes the responsibility of safety for yourself, your passengers, the people you lend your watercraft to, and other water users. Please follow all safety instructions and operate your watercraft with care. Be sure every operator of your watercraft fully understands the controls and operation of it and the importance of courteous, responsible riding. Each operator has a responsibility to ensure the safety of his/her passenger(s) and of other water users. Always inform your passengers of safety precautions.

Some of the information contained in this safety section may be new to you while other information may be common sense or obvious. Irrespective, we want you to have a safe, pleasurable riding experience, so please take a few minutes of your time to completely read this short safety section. Although the mere reading of such information does not eliminate the hazard, the understanding and application of the information will promote the correct use of the watercraft.

Failure to follow this safety section may result in severe injury or death.

This safety section is for initial reference and its content is therefore limited. It should be read in conjunction with the rest of this Operator's Guide, the *SAFETY VIDEO* and the on-product warning/caution labels. It is also strongly recommended that operators obtain further information concerning "Boating Rules" from a local Coast Guard Auxiliary, Powerboat Squadron or other local boating authorities.

Many states or provinces have requirements regarding boating safety and competence certificates. BRP strongly recommends that any watercraft operator completes a safety and competence boating course. Check with your local Coast Guard or Power Sail Squadron in your area for course availability.

Some boating safety information can be obtained from the Boating Safety/Regulation Web sites listed at the end of this safety section.

Regulations concerning boating are modified from time to time. It is advisable to periodically check the local regulations wherever you plan to operate your watercraft.

We encourage you to have an Annual Safety Inspection of your personal watercraft. Please contact your dealer for further details.

Finally, we urge you to visit your dealer regularly for regular and safety maintenance and for any accessories you may require.

Have fun and... Bon Voyage.

SAFETY CHECK LIST

To fully appreciate the pleasures, enjoyment and excitement of boating there are some basic rules that should be observed and followed by any boater. Failure to follow this safety information and safe boating rules could result in injury, including the possibility of death to you, your passenger(s), the people you lend your watercraft to, or other water users.

General

BRP recommends a minimum operator age of 16 years old.

A boating safety course is recommended and may be required in your province or state.

The performance of this watercraft may significantly exceed that of other craft you may have operated. Make sure to become completely familiar with the controls and operation of the watercraft before embarking on your first trip or taking on a passenger(s). If you have not had the opportunity to do so, practice driving solo in a suitable traffic free area and feel the response of each control. Be fully familiar with all controls before accelerating above idle speed. Do not assume that all PWCs handle identically. Each model differs, often substantially.

The operator of the watercraft controls, and is responsible for the watercraft's safe operation. He/she also has the responsibility to require that passenger(s) and people, to whom he/she lends the watercraft to, read and understand this safety section Operator's Guide, the *SAFETY VIDEO* and the on-product warning/caution labels.

Ensure that all passengers know how to swim and how to reboard the watercraft from the water.

Boarding in deep water can be strenuous. Practice in chest-deep water before operating or embarking your watercraft in deep water.

A PWC will not self-right if capsized. The operator and passengers must know the proper righting procedure as explained in the Operator's Guide. Make sure engine is off before rolling over the watercraft.

Your local Power Squadron or state/provincial authorities will be pleased to conduct a complementary safety examination of your watercraft and help you define your needs.

Never ride after consuming drugs or alcohol or if you feel tired or ill.

When fueling, follow the safe boating fueling instructions explicitly, as provided in your Operator's Guide and those given to you at the marina. Always verify fuel level before use and during the ride. Apply the principle of 1/3 fuel to destination, 1/3 back and 1/3 reserve fuel supply. Do not carry spare fuel or flammable liquids in any of the storage or engine compartments.

Always stop the engine before fueling and never allow anyone to remain on the watercraft while fueling. Always remember that fuel is flammable and explosive under certain conditions. Do not smoke or allow open flames or sparks in the vicinity.

Respect no wake zones, the rights of other water users and the environment. As the "skipper" and owner of a watercraft you are responsible for damage to other crafts caused by the wake of your watercraft. Allow no one to throw refuse overboard.

Don't forget that all persons must assist other boaters in an emergency.

GETTING UNDERWAY

To Wear

The operator and passenger(s) must wear a Coast Guard approved Personal Flotation Device (PFD) that is suitable for PWC use.

An operator and the watercraft's passenger(s) should have ready access to shatterproof glasses should riding conditions or personal preference warrant. Wind, water spray and speed may cause a person's eyes to water and create blurred vision.

The operator and passenger(s) of PWCs must wear protective clothing, including:

- A wet suit bottom or thick, tightly woven, snug fitting clothing that provides equivalent protection. Thin bike shorts for example would not be appropriate. Severe internal injuries can occur if water is forced into body cavities as a result of falling into water or being near jet thrust nozzle. Normal swimwear does not adequately protect against forceful water entry into the lower body opening(s) of males or females.
- Footwear, gloves and goggles/glasses are also recommended. Some type of lightweight, flexible foot protection is recommended. This will help reduce possible injury, should you step on sharp underwater objects.

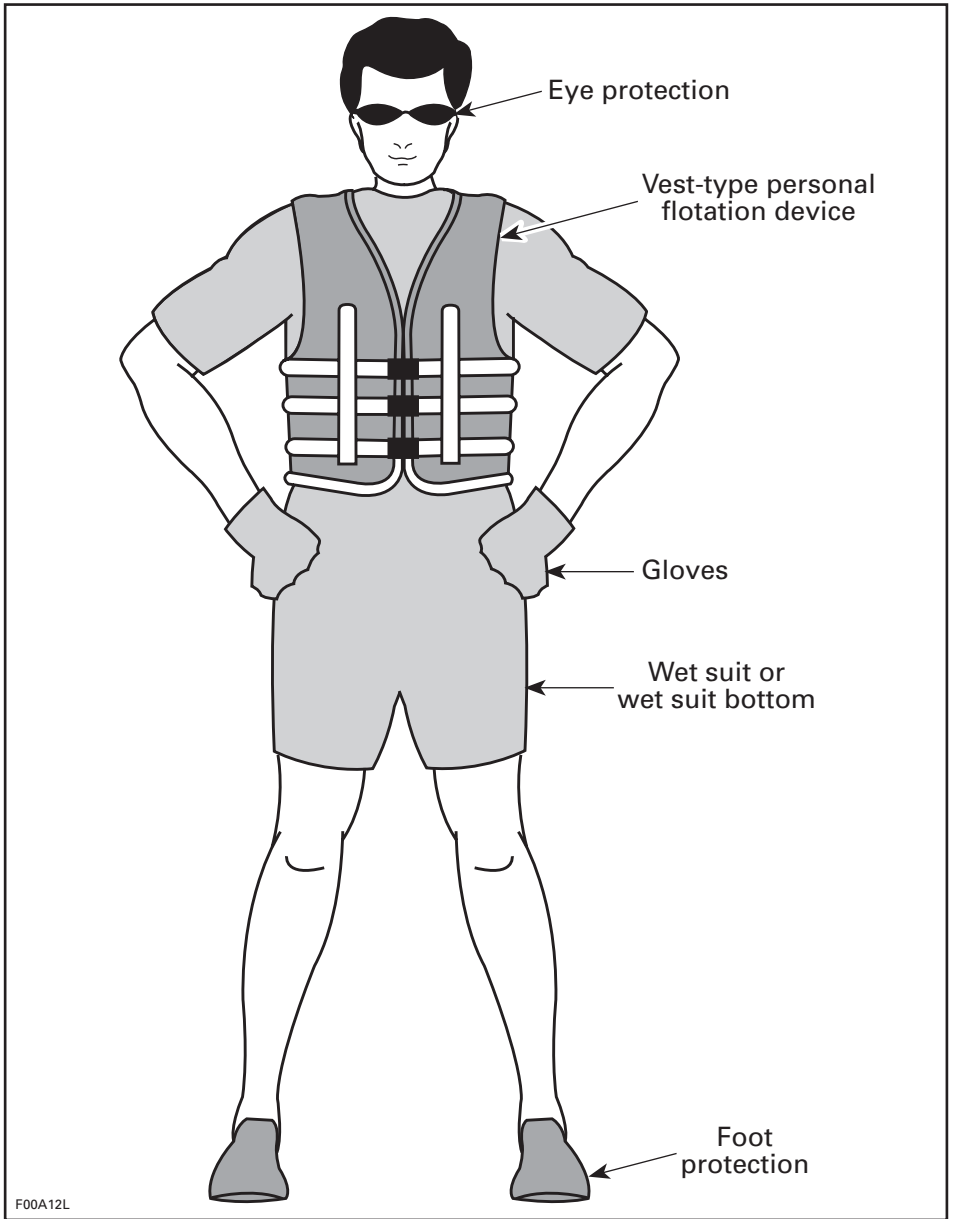

F00A12L

Helmets

Some Important Considerations

Helmets are designed to offer some degree of protection in case of impact to the head. In most motorized sports, the benefits of wearing a helmet clearly outweigh the drawbacks. However, in the case of motorized watersports such as riding personal watercraft, this is not necessarily true as there are some particular risks associated with the water.

Benefits

A helmet helps to reduce the risk of injury in case of a head impact against a hard surface such as another craft, for example, in the case of a collision. Similarly, a helmet with a chinguard might help prevent injuries to the face, jaw, or teeth.

Risks

On the other hand, in some situations when falling off the watercraft, helmets have a tendency to catch the water, like a "bucket", and put severe stresses on the neck or spine. This could result in choking, severe or permanent neck or spine injury, or death.

Helmets may also interfere with peripheral vision and hearing, or increase fatigue, which could contribute to increase the risk of a collision.

Weighing the Risks vs Benefits

In order to decide whether or not you should wear a helmet, it is best to consider the particular environment you will be riding in, as well as other factors such as personal experience. Will there be a lot of traffic on the water? What is your riding style?

The Bottom Line

Since each option minimizes some risks, but increases others, before each ride you must decide whether to wear a helmet or not based on your particular situation.

If you decide to wear a helmet, you must then decide what type is the most appropriate for the circumstances. Look for helmets that meet DOT or Snell standards, and if possible, choose one designed for motorized watersports.

Racing

Due to the nature of competition and the proximity of other crafts, BRP recommends wearing a helmet in close quarter PWC racing activities. Always follow the helmet requirements of the sanctioning organization.

To Bring

Always carry the regulatory safety items and have them conveniently on board available for use. Check the local regulations or consult your authorized Sea-Doo dealer. Such required safety items usually include, without limitation, a sound signaling device such as a whistle, a watertight flashlight or approved flares, a buoyant heaving line, an anchor and rope*, a bailer*, and an appropriate fire extinguisher*. The items marked with a "*" are not required in Canada if all persons on board a PWC are wearing a PFD.

A cellular telephone in a waterproof bag or container has also been found to be beneficial to boaters when in distress or just for contacting someone on shore.

To Do

Read and understand all warning/caution labels on your Sea-Doo PWC, your Operator's Guide, all other safety documents, and watch properly your *SAFETY VIDEO*, before operating. Always keep in mind that the "⚠" symbol, the Warning symbol, identifies an instruction which, if not followed, may cause serious personal injuries including the possibility of death.

Check local and federal boating laws applicable to the waterways where you intend to use your watercraft. Learn the local rules of the road. Know and understand the applicable navigation system (such as buoys and signs).

Know the waters in which the watercraft is to be operated. Current, tides, rapids, hidden obstacles, wakes and waves etc. can affect safe operation. It is not advisable to operate the watercraft in rough or inclement weather.

For safety reasons and proper care, always perform "Daily Pre-operation Checks" as specified in your Operator's Guide before operating your watercraft.

Keep the engine shut-off cord (safety lanyard) attached to the operator's PFD at all times and keep it free from handlebars so that engine stops if operator falls off. After riding, remove cord from PWC to avoid unauthorized use by children or others. If operator falls off the watercraft and safety lanyard is unattached, the watercraft will not stop.

OPERATION

Collision Avoidance

Do not release throttle when trying to steer away from objects. You need throttle to steer.

Always keep a constant lookout for other water users, other boats or objects, especially when turning. Be alert for conditions that may limit your visibility or block your vision of others.

Respect the rights of other recreationists and/or bystanders and always keep a safe distance from all other craft, people and objects.

Do not wake or wave jump, ride the surf line or attempt to spray or splash others with your watercraft. You may misjudge the ability of the watercraft or your own riding skills and strike a boat or person.

This watercraft has the capability of turning more sharply than other boats, however, unless in an emergency, do not negotiate sharp, high speed turns. Such maneuvers make it hard for others to avoid you or understand where you are going. Also, you and/or your passenger(s) could be thrown from the watercraft.

Like any other craft, this PWC has no brake. Stopping distance will vary depending on initial speed, load, wind, and water conditions. Practice stopping and docking in a safe, traffic free area to have an idea of how long it will take to stop the watercraft under varying conditions.

Maintaining or increasing speed may be necessary to avoid a collision.

Safe Riding

Always keep in mind that as the throttle lever is released to idle position, less directional control is available, and as the engine is off, directional control is lost. You need throttle to steer.

Ride within your limits and level of riding ability. Avoid aggressive maneuvers to reduce the risk of loss of control, ejection and collision. Understand and respect the performance of your watercraft.

Always ride responsibly and safely. Use common sense and courtesy.

While your watercraft has the capacity of operating at high speeds, it is strongly recommended that high speed operation only be applied when ideal conditions exist and are permitted. Higher speed operation requires a higher degree of skill and increases the risk of severe injuries.

The forces generated on the body of riders while turning, negotiating waves or wakes, operating in choppy waters, or falling off the watercraft, especially at higher speeds, may cause injury including the possibility of broken legs and other bones or more serious injuries. Remain flexible and avoid sharp turns.

In shallow water, proceed with caution and at very low speeds. Grounding or abrupt stops may result in injury. Debris may also be picked up and be thrown rearward by the jet pump onto people or property.

Do not use the watercraft's reverse, if so equipped, to stop. You or your passenger(s) could be violently ejected forward onto the handlebars or even off the watercraft onto the hazard.

PWCs are not designed for night-time operation.

Operator/Passenger Awareness

The watercraft operator has the responsibility to inform passenger(s) of safety measures.

Never turn handlebar while someone is nearby rear of watercraft. Keep away from steering moving parts (nozzle, side vanes, linkage, etc.).

Do not start or operate the watercraft if anyone is seated on the sun deck, if so equipped, or swim platform, or is nearby in the water. Water and/or debris exiting jet thrust nozzle can cause severe injury.

The operator and passenger(s) should be properly seated before starting or moving the watercraft, and at all times when watercraft is in motion. All passenger(s) should be instructed to use the handholds or seat straps provided, or in the alternative on a PWC, to hold the waist of the person in front of them.

When accelerating on a PWC with a passenger(s), whether from a complete stop or while underway, always do so progressively. Fast acceleration may cause your passenger(s) to lose their balance or grip and fall rearward off the watercraft. Make sure that your passenger(s) know of, or anticipate, any rapid acceleration.

Keep away from intake grate while engine is on. Items such as long hair, loose clothing, or PFD straps can become entangled in moving parts resulting in severe injury or drowning.

To prevent accidental starting, always detach the safety lanyard from the watercraft when swimmers are boarding or nearby, or during removal of any weeds or debris from the intake grate.

It should be remembered that sun, wind, alcohol, drugs, fatigue and illness, may impair your judgement and reaction time.

On a PWC, never place your feet and legs in the water to aid turning.

Manoeuvrability of the Watercraft/Towing

Do not overload the watercraft or take on more passengers than designated for the particular watercraft. Overloading can affect maneuverability, stability and performance.

Avoid adding on accessories, or equipment which may alter your control of the watercraft.

The watercraft may be fitted with tow eyelets which can be used to attach a ski rope.

Riding with a passenger(s) or pulling a tube, skier or wakeboarder makes the watercraft handle differently and requires greater skill.

Always respect the safety and comfort of your passenger(s) and person being towed on skis, wakeboard or other water products.

Always carry an observer when pulling a tube, skier or wakeboarder, proceed with only as much speed as required and follow the observer's instructions. Unless absolutely necessary, do not make tight, sharp turns. Keep a safe distance from the docks, other swimmers, craft or objects.

Use a tow rope of sufficient length and size and make sure it is adequately secured to your watercraft. While some craft are equipped or can be fitted with a specially designed towing mechanism avoid installing a tow pole on a PWC. It can become a hazard should someone fall on it.

Be advised that serious injury can result if the tow rope becomes slack during a tight turn or when circling. The rope could become wrapped around the neck or limbs of a person that has fallen in the water.

With wakeboard and/or rack installed, operate with extra caution: never perform aggressive maneuvers including spin-out; never jump waves; use common sense and limit speed. Otherwise, wakeboard could detach or occupants could fall off and get injured against the wakeboard or rack.

Don't forget: Ride smart from the start and we all win!

OPERATING RULES

Operating a watercraft can be compared with driving unmarked highways and roads. To prevent collisions or avoid other boaters, a system of operating rules must be followed. It's not only common sense... it's the law!

Remember these Rules of the Road

Know the Right of Way Rules

Generally keep to your right and safely avoid other craft by keeping a safe distance from other craft, people and objects.

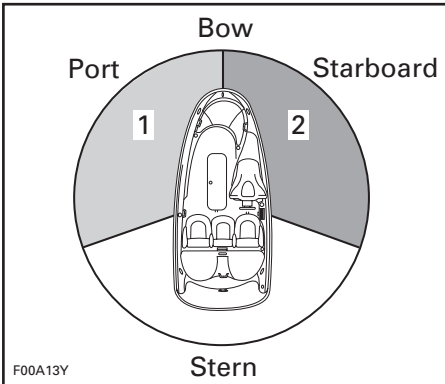

1. RED light
2. GREEN light (yield zone)

Crossing

Give right of way to craft ahead and to your right. Never cross in front of a boat;

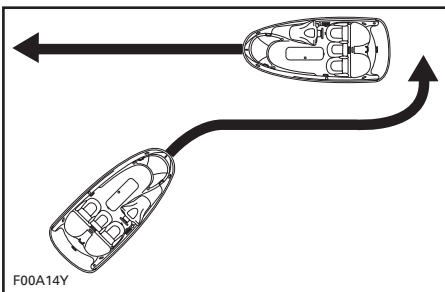

Meeting Head-On

Keep right.

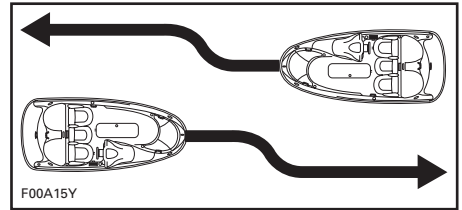

Passing

Give right of way to other craft and keep clear.

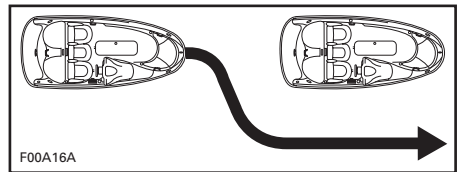

Navigation System

Navigational aids, such as signs or buoys, can assist you identify safe waters. Buoys will indicate whether you should keep to the right (starboard) or to the left (port) of the buoy or to which channel you can continue. They may also indicate whether you are entering a restricted or controlled area such as a no wake or speed zone. They may also indicate hazards or pertinent boating information. Markers maybe located on shore or on the water. They can also indicate speed limits, no power craft or boating, anchorage and other useful information. (The shape of each type of marker will provide assistance).

Make sure you know and understand the navigation system applicable to the waterways where you intend to use the watercraft.

WATERSKIING SIGNALS

For your information, here are the most commonly used waterskiing signals.

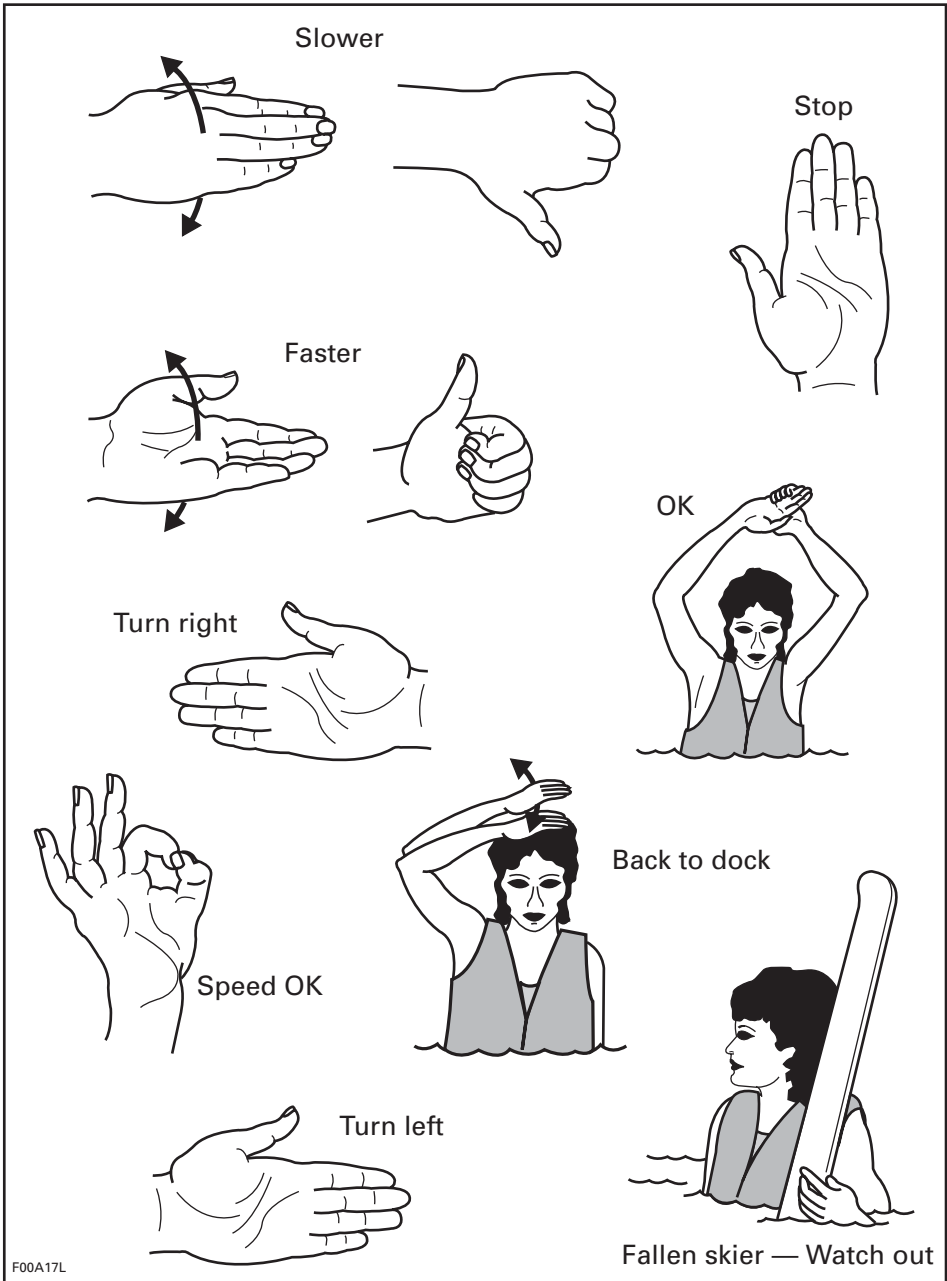

WEB SITES

Sea-Doo website: www.sea-doo.com

Canadian Coast Guard (Office of Boating Safety)	www.ccg-gcc.gc.ca/obs-bsn/sbg-gsn/main_e.htm
United States Coast Guard	www.uscgboating.org/regulations/boating_laws.htm
Alabama	www.dcnr.state.al.us/mp/menu.htm
Alaska	www.dnr.state.ak.us/parks/boating
Arizona	www.azgfd.com
Arkansas	www.agfc.state.ar.us/
California	www.dbw.ca.gov
Colorado	http://parks.state.co.us/boating/
Connecticut	http://dep.state.ct.us/rec/prgactiv.htm
Delaware	www.dnrec.state.de.us/fw/index.htm
Florida (freshwater)	http://floridaconservation.org/law
Florida (saltwater)	www.dep.state.fl.us/law
Georgia	www.boat-ed.com
Hawaii	www.hawaii.gov/dlnr/dbor/dbor
Idaho	www.idahoparks.org/rec/boating.html
Indiana	www.state.in.us/dnr/regulations
Iowa	www.iowadnr.com/
Kansas	www.kdwp.state.ks.us/boating/boating.html
Kentucky	www.state.ky.us/agencies/fw/boating.htm
Louisiana	www.wlf.state.la.us
Maine	www.state.me.us/ifw/rv/boatinglaws2002.htm
Maryland	www.dnr.state.md.us/boating
Massachusetts	www.state.ma.us/dfwele/dle/boatrvsafe.htm
Michigan	www.boat-ed.com/mi/handbook
Minnesota	www.dnr.state.mn.us/safety/boatwater
Mississippi	www.dmr.state.ms.us
Missouri	www.mswp.state.mo.us
Montana	www.fwp.state.mt.us/education/outdoorskills.asp
Nebraska	www.ngpc.state.ne.us/boating
Nevada	http://www.boatnevada.org/
New Hampshire	www.state.nh.us/safety/ss/links.html

New Jersey	www.state.nj.us/mvs/boats.htm
New Mexico	www.emnrd.state.nm.us/nmparks/pages/question/regulate/rules/nmac172.pdf
North Carolina	www.ncwildlife.org/fs_index_02_regulations.htm
North Dakota	http://www.state.nd.us/gnf/boating/
Ohio	www.dnr.state.oh.us/odnr/watercraft
Oregon	www.osmb.state.or.us
Pennsylvania	www.fish.state.pa.us
Rhode Island	www.state.ri.us/dem/topics/boating.htm
South Carolina	www.dnr.state.sc.us/etc/boating.html
South Dakota	www.state.sd.us/gfp/divisionwildlife/boating/index.htm
Tennessee	www.state.tn.us/twra/boatmain.html
Texas	www.tpwd.state.tx.us/boat/boat.htm
Utah	www.stateparks.utah.gov/parks/safety.htm
Virginia	www.dgif.state.va.us/boating
Washington	www.parks.wa.gov/boating.asp
West Virginia	www.dnr.state.wv.us/law/boating.htm
Wisconsin	http://www.dnr.state.wi.us/org/caer/cs/Registrations/Boats.htm
Wyoming	http://gf.state.wy.us

NOTE: State websites not listed are under development. BRP makes no representation of endorsement of any of the products or services contain within any website listed.

LOCATION OF THE IMPORTANT LABELS

The following labels are on your watercraft. If missing or damaged, they can be replaced free of charge. See an authorized Sea-Doo dealer.

Please read the following labels carefully before operating this watercraft.



TYPICAL — GTI MODELS

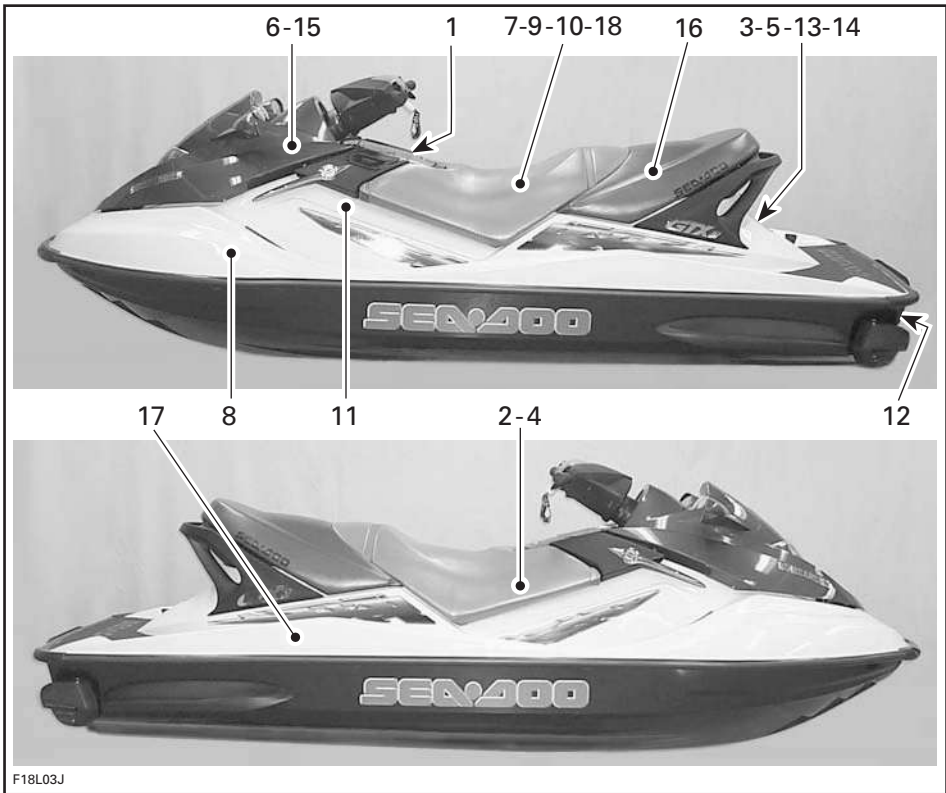

TYPICAL — OTHER MODELS

Label 1

⚠ WARNING

To reduce the risk of **SEVERE INJURY** or **DEATH**:

WEAR A PERSONAL FLOTATION DEVICE (PFD). All riders must wear a Coast Guard approved PFD that is suitable for personal watercraft (PWC) use.

WEAR PROTECTIVE CLOTHING. Severe internal injuries can occur if water is forced into body cavities as a result of falling into water or being near jet thrust nozzle. Normal swimwear does not adequately protect against forceful water entry into lower body opening(s) of males or females. All riders must wear a wet suit bottom or clothing that provides equivalent protection (see Operator's Guide). Footwear, gloves and goggles/glasses are recommended.

KNOW BOATING LAWS. Bombardier recommends a minimum operator age of 16 years old. Know the operator age and training requirements for your province/state. A boating safety course is recommended and may be required in your province/state.

ATTACH ENGINE SHUT-OFF CORD (LANYARD) to PFD and keep it free from handlebars so that engine stops if operator falls off. After riding, remove cord from PWC to avoid unauthorized use by children or others.

RIDE WITHIN YOUR LIMITS AND AVOID AGGRESSIVE MANEUVERS to reduce the risk of loss of control, ejection and collision. This is a high performance boat - not a toy. Sharp turns or jumping wakes or waves can increase the risk of back/spinal injury (paralysis), facial injuries, and broken legs, ankles, and other bones. **Do not jump wakes or waves.**

DO NOT APPLY THROTTLE WHEN ANYONE IS AT REAR OF PWC - turn engine off or keep engine at idle. Water and/or debris exiting jet thrust nozzle can cause severe injury.

KEEP AWAY FROM INTAKE GRATE while engine is on. Items such as long hair, loose clothing, or PFD straps can become entangled in moving parts resulting in severe injury or drowning.

NEVER RIDE AFTER CONSUMING DRUGS OR ALCOHOL

READ AND FOLLOW OPERATOR'S GUIDE

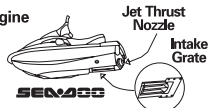

⚠ WARNING

Collisions result in more **INJURIES AND DEATHS** than any other type of accident for personal watercraft (PWC).

TO AVOID COLLISIONS:

SCAN CONSTANTLY for people, objects, and other watercraft. Be alert for conditions that limit your visibility or block your vision of others.

OPERATE DEFENSIVELY at safe speeds and keep a safe distance away from people, objects, and other watercraft.

- Do not follow directly behind PWCs or other boats.
- Do not go near others to spray or splash them with water.
- Avoid sharp turns or other maneuvers that make it hard for others to avoid you or understand where you are going.
- Avoid areas with submerged objects or shallow water.

TAKE EARLY ACTION to avoid collisions. Remember, PWCs and other boats **do not have brakes**.

DO NOT RELEASE THROTTLE WHEN TRYING TO STEER away from objects - **you need throttle to steer**. Always check throttle and steering controls for proper operation before starting PWC.

Follow navigation rules and province/state and local laws that apply to PWCs. See Operator's Guide for more information. Seating is limited to XX operator and XX passengers (XXX lbs./XXX kg.).



F12L0FL

219 901 713

TYPICAL — SOME MODELS

Label 1 (cont'd)

WARNING

To reduce the risk of **SEVERE INJURY** or **DEATH**:
WEAR A PERSONAL FLOTATION DEVICE (PFD). All riders must wear a Coast Guard approved PFD that is suitable for personal watercraft (PWC) use.

WEAR PROTECTIVE CLOTHING. Severe internal injuries can occur if water is forced into body cavities as a result of falling into water or being near jet thrust nozzle. Normal swimwear does not adequately protect against forceful water entry into lower body opening(s) of males or females.

All riders must wear a wet suit bottom or clothing that provides equivalent protection (see Operator's Guide). Footwear, gloves and goggles/glasses are recommended.

KNOW BOATING LAWS. Bombardier recommends a minimum operator age of 16 years old. Know the operator age and training requirements for your province/state. A boating safety course is recommended and may be required in your province/state.

ATTACH ENGINE SHUT-OFF CORD (LANYARD) to PFD and keep it free from handlebars so that engine stops if operator falls off. After riding, remove cord from PWC to avoid unauthorized use by children or others.

RIDE WITHIN YOUR LIMITS AND AVOID AGGRESSIVE MANEUVERS to reduce the risk of loss of control, ejection and collision. This is a high performance boat - not a toy. Sharp turns or jumping wakes or waves can increase the risk of back/spinal injury (paralysis), facial injuries, and broken legs, ankles, and other bones.
Do not jump wakes or waves.

DO NOT APPLY THROTTLE WHEN ANYONE IS AT REAR OF PWC - turn engine off or keep engine at idle. Water and/or debris exiting jet thrust nozzle can cause severe injury.

KEEP AWAY FROM INTAKE GRATE while engine is on. Items such as long hair, loose clothing, or PFD straps can become entangled in moving parts resulting in severe injury or drowning.

NEVER RIDE AFTER CONSUMING DRUGS OR ALCOHOL

READ AND FOLLOW OPERATOR'S GUIDE

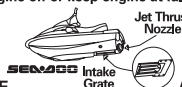

WARNING

Collisions result in more **INJURIES AND DEATHS** than any other type of accident for personal watercraft (PWC).

TO AVOID COLLISIONS:

SCAN CONSTANTLY for people, objects, and other watercraft. Be alert for conditions that limit your visibility or block your vision of others.

OPERATE DEFENSIVELY at safe speeds and keep a safe distance away from people, objects, and other watercraft.

- Do not follow directly behind PWCs or other boats.
- Do not go near others to spray or splash them with water.
- Avoid sharp turns or other maneuvers that make it hard for others to avoid you or understand where you are going.
- Avoid areas with submerged objects or shallow water.

TAKE EARLY ACTION to avoid collisions. Remember, PWCs and other boats do not have brakes.

DO NOT RELEASE THROTTLE WHEN TRYING TO STEER away from objects - you need throttle to steer.

Always check throttle and steering controls for proper operation before starting PWC.

Follow navigation rules and province/state and local laws that apply to PWCs. See Operator's Guide for more information.

Seating is limited to XX operator and XX passengers (XXX lbs./XXX kg.).



F16L0PL

TYPICAL — SOME MODELS

Label 1 (cont'd)

⚠ WARNING

To reduce the risk of **SEVERE INJURY** or **DEATH**:

WEAR A PERSONAL FLOTATION DEVICE (PFD). All riders must wear a Coast Guard approved PFD that is suitable for personal watercraft (PWC) use.

WEAR PROTECTIVE CLOTHING. Severe internal injuries can occur if water is forced into body cavities as a result of falling into water or being near jet thrust nozzle. Normal swimwear does not adequately protect against forceful water entry into lower body opening(s) of males or females. All riders must wear a wet suit bottom of clothing that provides equivalent protection (see Operator's Guide). Footwear, gloves, and goggles/glasses are recommended.

KNOW BOATING LAWS. Bombardier recommends a minimum operator age of 16 years old. Know the operator age and training requirements for your province/state. A boating safety course is recommended and may be required in your province/state.

ATTACH ENGINE SHUT-OFF CORD

(LANYARD) to PFD and keep it free from handlebars so that engine stops if operator falls off. After riding, remove cord from PWC to avoid unauthorized use by children or others.

RIDE WITHIN YOUR LIMITS AND AVOID AGGRESSIVE

MANEUVERS to reduce the risk of loss of control, ejection, and collision. This is a high performance boat – not a toy. Sharp turns or jumping wakes or waves can increase the risk of back/spinal injury (paralysis), facial injuries, and broken legs, ankles, and other bones. **Do not jump wakes or waves.**

DO NOT APPLY THROTTLE WHEN ANYONE IS AT REAR OF PWC – turn engine off or keep engine at idle. Water and/or debris exiting jet thrust nozzle can cause severe injury.



KEEP AWAY FROM INTAKE GRATE while engine is on. Items such as long hair, loose clothing, or PFD straps can become entangled in moving parts resulting in severe injury or drowning.

NEVER RIDE AFTER CONSUMING DRUGS OR ALCOHOL.

READ AND FOLLOW OPERATOR'S GUIDE



⚠ WARNING

Collisions result in more **INJURIES AND DEATHS** than any other type of accident for personal watercraft (PWC).

TO AVOID COLLISIONS: SCAN CONSTANTLY for people, objects, and other watercraft. Be alert for conditions that limit your visibility or block your vision of others.



at safe speeds and keep a safe distance away from people, objects, and other watercraft.

- Do not follow directly behind PWCs or other boats.
- Do not go near others to spray or splash them with water.
- Avoid sharp turns or other maneuvers that make it hard for others to avoid you or understand where you are going.
- Avoid areas with submerged objects or shallow water.

TAKE EARLY ACTION to avoid collisions. Remember, PWCs and other boats **do not have brakes.**

DO NOT RELEASE THROTTLE WHEN TRYING TO STEER away from objects – you need throttle to steer. Always check throttle and steering controls for proper operation before starting PWC. Follow navigation rules and province/state and local laws that apply to PWCs. See Operator's Guide for more information. Seating is limited to one operator and two passengers (535 lbs./243 kg.).

F18A06L

TYPICAL — SOME MODELS

Label 1 (cont'd)



F
N
R

⚠ WARNING

To reduce the risk of **SEVERE INJURY or DEATH: WEAR A PERSONAL FLOTATION DEVICE (PFD)**. All riders must wear Coast Guard approved PFD that is suitable for personal watercraft (PWC) use. **WEAR PROTECTIVE CLOTHING**. Severe internal injuries can occur if water is forced into body cavities as a result of falling into water or being near jet thrust nozzle. Normal swimwear does not adequately protect against forceful water entry into lower body opening(s) of males or females. All riders must wear a wet suit bottom or clothing that provides equivalent protection (see Operator's Guide). Footwear, gloves and goggles/glasses are recommended. **KNOW BOATING LAWS**. BRP recommends a minimum operator age of 16 years old. Know the operator age and training requirement for your province/state. A boating safety course is recommended and may be required in your province/state. **ATTACH ENGINE SHUT-OFF CORD (LANYARD) to PFD** and keep it free from handclashes so that engine stops if operator falls off. After riding, remove cord from PWC to avoid unauthorized use by children or others. **RIDE WITHIN YOUR LIMITS AND AVOID AGGRESSIVE MANEUVERS** to reduce the risk of loss of control, ejection, and collision. This is a high performance boat – not a toy. Sharp turns or jumping wakes or waves can increase the risk of back/ spinal injury (paralysis), facial injuries, and broken legs, ankles, and other bones. **Do not jump wakes or waves. DO NOT APPLY THROTTLE WHEN ANYONE IS AT REAR OF PWC** – turn engine off or keep engine at idle. Water and/or debris exiting jet thrust nozzle can cause severe injury.



KEEP AWAY FROM INTAKE GRATE while engine is on. Items such as long hair, loose clothing, or PFD straps can become entangled in moving parts resulting in severe injury or drowning. **NEVER RIDE AFTER CONSUMING DRUGS OR ALCOHOL. READ AND FOLLOW OPERATOR'S GUIDE.**

⚠ WARNING

Collisions result in more **INJURIES AND DEATHS** than any other type of accident for personal watercraft (PWC). **TO AVOID COLLISIONS: SCAN CONSTANTLY** for people, objects, and other watercraft. Be alert for conditions that limit your visibility or block your vision of others. **OPERATE DEFENSIVELY** at safe speeds and keep a safe distance away from people, objects, and other watercraft. • Do not follow directly behind PWCs or other boats. • Do not go near others to spray or splash them with water. • Avoid sharp turns or other maneuvers that make it hard for others to avoid you or understand where you are going. • Avoid areas with submerged objects or shallow water. **TAKE EARLY ACTION** to avoid collisions. Remember, PWCs and other boats do not have brakes. **DO NOT RELEASE THROTTLE WHEN TRYING TO STEER** away from objects – you need throttle to steer. Always check throttle and steering controls for proper operation before starting PWC. Follow navigation rules and province / state and local laws that apply to PWCs. See Operator's Guide for more information. Seating is limited to one operator and two passengers. (600lbs / 273kg).



219 002 522

sno2006-002-013

SOME MODELS

Label 2

BRP US Inc.
EMISSION CONTROL INFORMATION
This vehicle is certified to operate on unleaded gasoline and conforms to 20XX U.S. EPA & CALIFORNIA EMISSION regulations for marine SI engines.

BRP US Inc.
RENSEIGNEMENTS SUR LE DISPOSITIF ANTIPOLLUTION
Ce véhicule est certifié pour fonctionner à l'essence sans plomb et il répond aux normes 20XX de l'EPA des É.-U. & RÉGLEMENTATIONS CALIFORNIENNES pour les moteurs marins à étincelles (SI).

SEE OPERATORS GUIDE FOR MAINTENANCE SPECIFICATIONS.

Engine family	XXXX	Familie de moteur
FEL	XX g/kW-hr HC+NOx	Limite des émissions de la famille
Engine displacement	XXX cc	Cylindrée
Exhaust emission control system:		Système de contrôle des Émissions
Spark plug type	NGK	Type de bougie
Spark plug gap	XX mm	Écartement des électrodes
Power	XX kw	Puissance

VOIR MANUEL DE L'OPÉRATEUR POUR LES SPÉCIFICATIONS DE MAINTENANCE.

sno2006-002-014_a

Label 3

"THIS BOAT IS NOT REQUIRED TO COMPLY WITH THE FOLLOWING U.S. COAST GUARD SAFETY STANDARDS IN EFFECT ON THE DATE OF CERTIFICATION:

- FUEL SYSTEM
- DISPLAY OF CAPACITY INFORMATION
- SAFE LOADING
- FLOTATION
- POWERED VENTILATION

AS AUTHORIZED BY U.S. COAST GUARD GRANT OF EXEMPTION (OGB 88-001)."

BRP US Inc.
10101 Science Drive Sturtevant, Wisconsin 53177

MADE IN X X X

F22A0AY

TYPICAL

Label 4

▲ WARNING / AVERTISSEMENT
DO NOT CHARGE OR BOOST THE BATTERY WHILE INSTALLED ON THE WATERCRAFT

NE PAS CHARGER OU SURVOLTER LA BATTERIE LORSQUELLE EST INSTALLÉE DANS LA MOTOMARINE

F00A23Y

Label 5

▲ WARNING / AVERTISSEMENT

- Engine must be off when using boarding step.
- Keep away from jet and intake grate.
- Stay on center of the step.
- Only one person at a time on the step.
- Never use the step for pulling, towing, diving or jumping, boarding a PWC that is out of water or any other purpose for which it was not designed.

Le moteur doit être arrêté lorsqu'on utilise la marche d'embarquement.

- Se tenir à l'écart de la turbine et de la grille d'admission.
- Rester au centre de la marche.
- Une personne à la fois sur la marche.
- La marche ne doit jamais servir à tirer ou à remorquer la motomarine, à plonger, à sauter à l'eau, à embarquer sur la motomarine si elle n'est pas à l'eau ou pour toute autre activité pour laquelle elle n'a pas été conçue.

F00A26Y

SOME MODELS

Label 6

▲ WARNING / AVERTISSEMENT

- Gasoline vapors may cause fires or explosions.
- Do not overfill fuel tank.
- Keep the craft away from open flames and sparks.
- Do not start watercraft if liquid gasoline or vapors are present.
- Always replace seat (or engine cover) before starting.

Les émanations d'essence peuvent provoquer des incendies ou des explosions.

- Éviter de trop remplir le réservoir de carburant.
- Garder la motomarine à l'écart des flammes et des étincelles.
- Ne pas démarrer la motomarine en présence d'essence liquide ou d'émanation d'essence.
- Toujours remettre le siège (ou le couvercle du compartiment-moteur) en place avant de démarrer la motomarine.

F00A27Y

Label 7

▲ WARNING / AVERTISSEMENT
PRESSURIZED FUEL
Do not unscrew protective cap. Must be used only by Bombardier certified technician. Do not operate the watercraft without cap properly installed.

ESSENCE SOUS PRESSION
Ne pas dévisser le capuchon protecteur. Réservez seulement à l'usage d'un technicien certifié par Bombardier. Ne pas opérer la motomarine sans le capuchon bien installé.

F00A2QY

Label 8

VERY • LOW
CALIFORNIA EMISSION STANDARDS
EMISSION

F00L2YY

TYPICAL — SOME MODELS

Label 9

▲ WARNING / AVERTISSEMENT

When disconnecting coil from sparkplug, always disconnect coil from main harness first. Never check for engine ignition spark from an open coil and/or sparkplug in the engine compartment as spark may cause fuel vapor to ignite.

Lorsque vous déconnectez la bobine d'allumage de la bougie, toujours déconnecter la bobine d'allumage du harnais principal en premier. Ne jamais vérifier si le circuit d'allumage du moteur produit une étincelle en utilisant la bobine d'allumage et/ou la bougie dans le compartiment moteur car une étincelle pourrait entraîner l'allumage des vapeurs d'essence.

F18L0NY

Label 10

▲ WARNING / AVERTISSEMENT
CHECKING ENGINE OIL LEVEL
Vehicle must be level to perform verification. Bring engine to normal operating temperature then let idle for 30 seconds. Stop engine, wait for at least 30 sec. and check oil level using the dipstick. Caution: Never let the engine run out of the water without cooling through the flush kit connection as it may damage the engine. Oil may be hot.

VÉRIFICATION DU NIVEAU D'HUILE DU MOTEUR
Avec la motomarine à niveau et à température normale d'utilisation, laissez le moteur tourner au ralenti 30 secondes. Arrêtez le moteur, attendez au moins 30 sec. et vérifiez le niveau d'huile. Attention: Ne pas laisser tourner le moteur hors de l'eau sans faire circuler de l'eau par le raccord de rinçage. L'huile peut être chaude.

F18L10Y

TYPICAL

Label 11

CAUTION

- To comply with noise regulations, this engine is designed to operate with an air intake silencer.
- Operation without air intake silencer or with one not properly installed may cause engine damage.

ATTENTION

- Le moteur a été conçu pour fonctionner avec ce silencieux d'admission afin de se conformer aux lois et règlements relatifs au bruit.
- Son absence ou une mauvaise installation peut endommager le moteur.

F00A2EY 516 001 191

Label 12

⚠ WARNING

When operating the engine while the watercraft is out of the water, the heat exchanger in the rida plate may become very hot. Avoid any contact with rida plate as burns may occur.

⚠ AVERTISSEMENT

Faire fonctionner le moteur quand le véhicule est hors de l'eau peut rendre le radiateur incorporé à la plaque promenade très chaud. Éviter tout contact avec la plaque de promenade, des brûlures peuvent survenir.

F18L0YY 2592527

TYPICAL

Label 13

⚠ WARNING

- Completely retract ski post when not used
- Do not hold rear grab handle while retracting ski post
- Make sure ski post is fully extended and locked before use
- Spotter must always keep hands on ski post grips while pulling a skier or wakeboarder

219 902 218

⚠ AVERTISSEMENT

- Rétracter complètement la tige de fixation du câble lorsqu'il n'est pas utilisé
- Ne pas tenir la poignée arrière en rétractant la tige de fixation
- S'assurer que la tige de fixation est complètement sortie et verrouillée avant utilisation
- L'observateur doit toujours garder ses mains sur les poignées de la tige de fixation lorsqu'un planchiste ou un skieur est remorqué

F00A2SL

SOME MODELS

Label 14

CE 0609 

BOAT CATEGORY: PWC

Max.  = 3

Max.  +  = 273 kg

Bombardier Recreational Products Inc. 21902037

smo2006-002-015

CE 0609 

BOAT CATEGORY: PWC

Max.  = 2

Max.  +  = 181 kg

Bombardier Recreational Products Inc. 21902038

smo2006-002-016

Label 15

<p>CAUTION</p> <p>Recommended: Premium unleaded gasoline 91 pump octane or higher.</p> <p>Minimum: Regular unleaded gasoline 87 pump octane or higher.</p> <p>ATTENTION</p> <p>Recommandé: Essence super sans plomb 91 octane ou plus.</p> <p>Minimum requis: Essence ordinaire sans plomb 87 octane.</p>

F18L31Y

SOME MODELS

Label 18

<p>WARNING</p> <p>Certain components in the engine compartment may be very hot. Direct contact may result in skin burn.</p>	<p>AVERTISSEMENT</p> <p>Certaines composantes dans l'habitacle du moteur peuvent être très chaudes. Le contact direct sur la peau peut causer des brûlures.</p>
--	--

F00A1AY

Label 16



Label 17

<p>Always:</p> <ul style="list-style-type: none">• Secure RACK properly• Position board with FINS OUTWARD• Secure BOARD properly <p>219902347</p> <p>WARNING</p>

F18L3KY

SOME MODELS

VEHICLE INFORMATION

REGISTRATION NUMBER LOCATION

All personal watercraft are required by federal law to be registered and legally numbered.

Due to space availability for proper display of registration number, refer to following illustration for location. The registration number should appear on each side of the watercraft. On applicable models install registration number to the left of the star label.



TYPICAL

1. Registration number location

NOTE: The registration number must be above the water line. Ensure also that the numbers are of the correct size and color. Check with local applicable regulations.

IDENTIFICATION NUMBERS

The main components of the watercraft (engine and hull) are identified by different serial numbers. It may sometimes become necessary to locate these numbers for warranty purposes or to trace the watercraft in the event of theft.

Hull

The Hull Identification Number (H.I.N.) is located on footboard at the rear of watercraft.

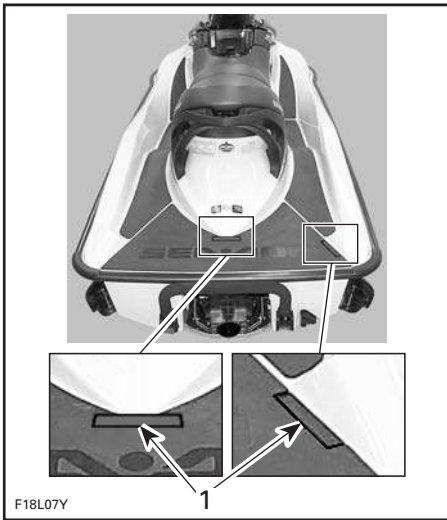

TYPICAL

1. Hull Identification Number (H.I.N.)

It is composed of 12 digits:

YDV 12345 L 4 95
Model year
Year of production
Month of production
Serial number (a letter may also be used as a digit)
Manufacturer

Engine

NOTE: Refer to *SPECIFICATIONS* section to find what engine is used on each model.

The Engine Identification Number (E.I.N.) is located on the front end of the engine.



TYPICAL

1. Engine Identification Number (E.I.N.)

CONTROLS/INSTRUMENTS/EQUIPMENTS

NOTE: Some components do not apply or are optional on some models.

GTI Models

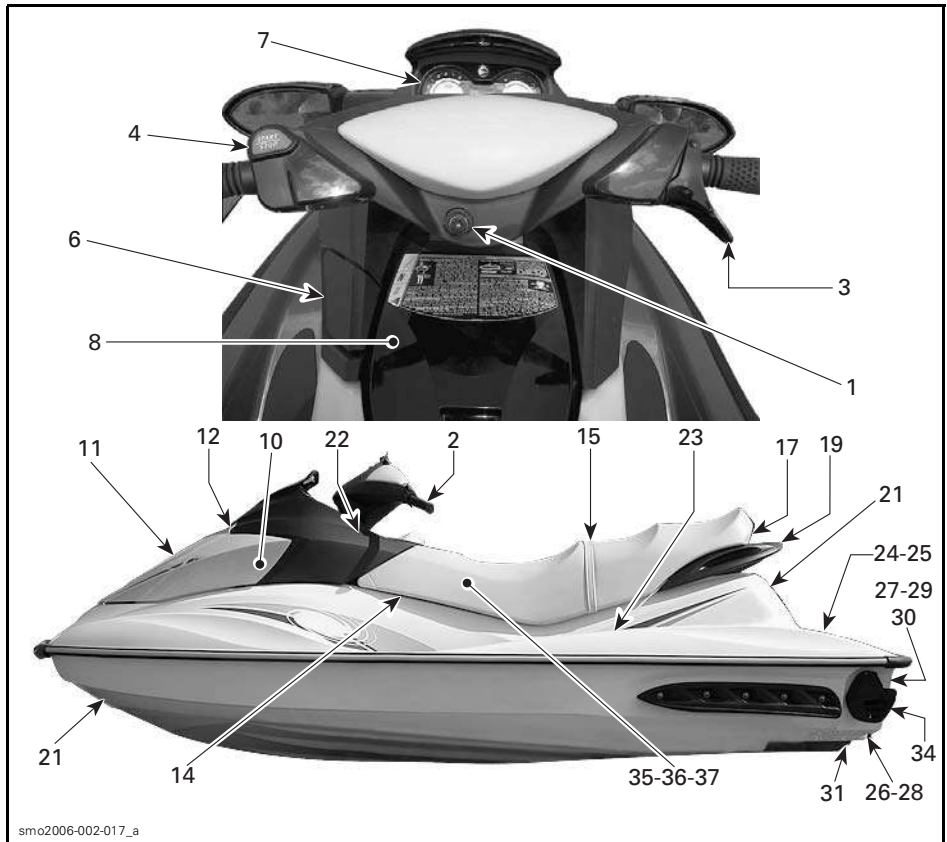

GTX/RXT Models

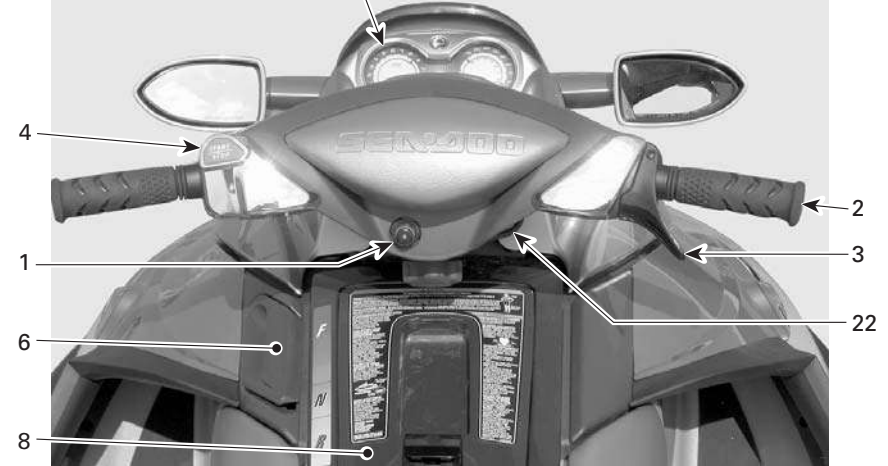
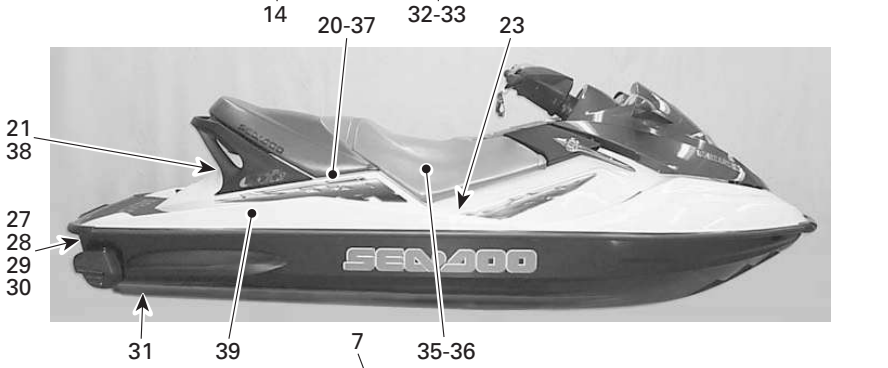
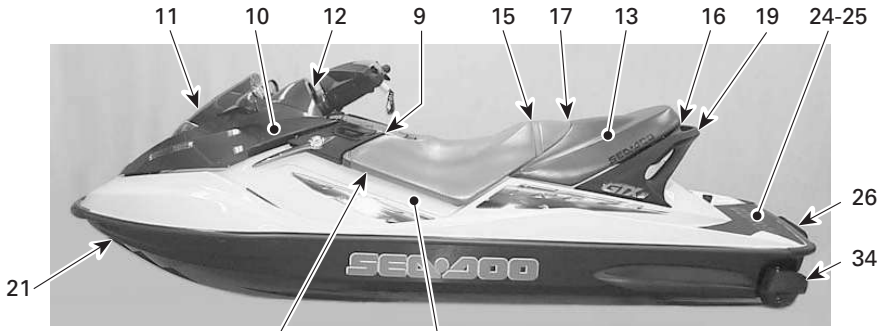

sno2006-002-018_a

TYPICAL

RXP Models

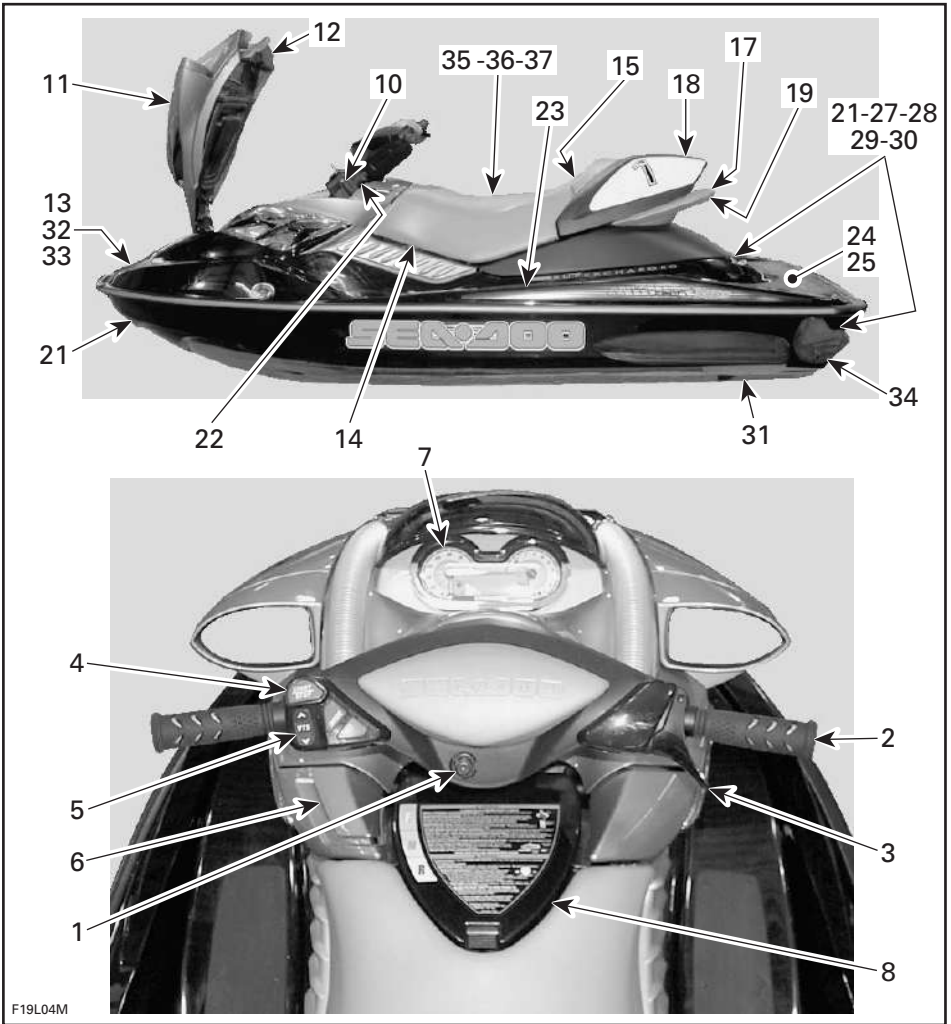

1. Safety Lanyard (engine cut-off cord)
2. Handlebar
3. Throttle Lever
4. Engine Start/Stop Button
5. Variable Trim System (VTS) Button
6. Shift Lever
7. Speedometer
8. Glove Box
9. GPS (Global Positioning System) receiver
10. Fuel Tank Cap
11. Front Storage Compartment Cover
12. Front Storage Compartment Cover Latch
13. Tool Kit
14. Air Intake Opening
15. Seat Strap
16. Seat Extension Latch
17. Seat Latch
18. Seat Cover
19. Rear Grab Handle
20. Rear Storage Basket
21. Front and Rear (bow/stern) Eye-lets
22. Mooring Cleats
23. Footboard
24. Boarding Pads
25. Boarding Platform
26. Boarding Step
27. Flushing Connector
28. Bilge Drain Plugs
29. Jet Pump Nozzle
30. Reverse Gate
31. Jet Pump Water Intake
32. Fuses
33. Battery
34. Side Vanes
35. Engine Oil Dipstick
36. Engine Oil Filling Cap
37. Cooling System Expansion Tank Cap
38. Ski/Wakeboard Post
39. Wakeboard Rack

CONTROLS/INSTRUMENTS/EQUIPMENTS FUNCTIONS

1) Safety Lanyard (engine cut-off cord)

The safety lanyard cap should be securely snapped onto its post to be fully operational.

Pulling the safety lanyard cap from its post stops the engine operation.

WARNING

While engine can be stopped using the engine start/stop button, good habits recommend that the safety lanyard also be disconnected when stopping.

Attach the safety lanyard to the operator's Personal Flotation Device (PFD) and snap the cap to the post to be able to start the engine.

Two short beeps indicates the system is ready to allow engine starting. Otherwise, refer to the *TROUBLESHOOTING* section for the coded signals chart.

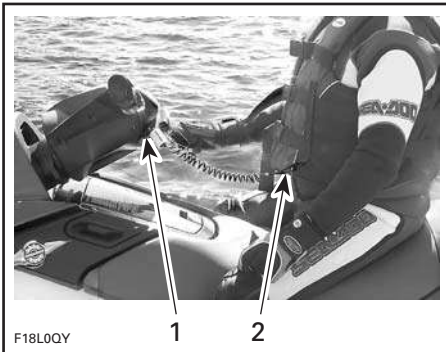

TYPICAL

1. Safety lanyard cap on the post
2. Safety lanyard secured on operator's PFD

WARNING

Should the engine be stopped, watercraft directional control is reduced. Always disconnect safety lanyard when watercraft is not in operation in order to prevent accidental engine starting or to avoid unauthorized use by children or others or theft.

If engine is not started within 5 seconds after installing the safety lanyard on its post, 4 very short beeps every 3 second interval will sound for approximately 4 hours to remind you to start the engine or to remove safety lanyard. Afterwards, the beeps will stop. The same will occur when safety lanyard is left on its post 5 seconds after engine is stopped.

Always ensure safety lanyard is not left on its post after engine is stopped.

IMPORTANT: Leaving the safety lanyard on its post when engine is not running will slowly discharge the battery.

Digitally Encoded Security System (DESS)

The safety lanyard cap specifically contains an electronic circuit that gives it a unique electronic serial number. This is the equivalent of a conventional key.

This safety lanyard cannot be used on another watercraft and conversely, the one from another watercraft cannot be used on your watercraft.

However, the DESS brings a great flexibility. You can buy an additional safety lanyard and have it programmed for your watercraft.

To have additional safety lanyard, refer to an authorized Sea-Doo dealer.

Limited-Speed Operation

Some 4-TEC models are equipped with special safety lanyard.

The SEA-DOO Learning Key™ or the SEA-DOO Rental Key electronically limits the speed of the watercraft, therefore enabling first time users and less experienced operators to learn how to operate the watercraft while gaining the necessary confidence and control.

Models Equipped with SEA-DOO Learning Key

With the SEA-DOO Learning Key™, the watercraft speed is limited to approximately 55 km/h (35 MPH).



Models Equipped with SEA-DOO Rental Key

With the SEA-DOO Rental Key, the watercraft speed is limited to approximately 70 km/h (45 MPH).



2) Handlebar

The handlebar controls the direction of the watercraft. Turning the handlebar to the right steers the watercraft to the right and inversely.

WARNING

Check handlebar and corresponding steering nozzle and side vanes operation before starting. Never turn handlebar while someone is nearby rear of watercraft. Keep away from steering moving parts (nozzle, side vanes, linkage etc.).

Adjustment (if so equipped)

The handlebar height can be adjusted to suit rider preferences.

To perform this adjustment, turn the knob underneath the handlebar.

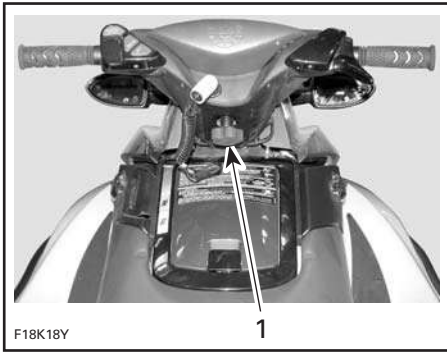

F18K18Y

1

TYPICAL

1. Adjustment knob

3) Throttle Lever

When the throttle lever is pushed, the watercraft accelerates. When fully released, engine automatically slows down to idle speed and watercraft is gradually stopped by water drag.

4) Engine Start/Stop Button

To start engine, depress and hold the start/stop button. Release immediately after engine is started.

To stop engine, depress the start/stop button. When stopped, disconnect safety lanyard from the post. It is suggested to release throttle lever first.

WARNING

Directional control is reduced when the throttle is released or when engine is off.

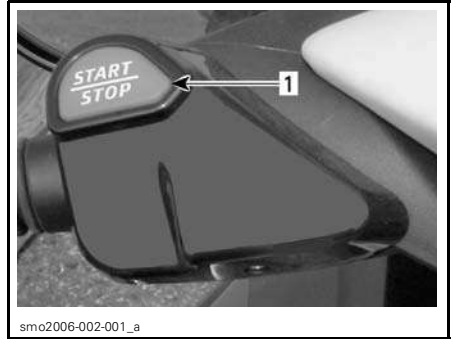

smo2006-002-001_a

1. Engine start/stop button

5) Variable Trim System (VTS) Button (if so equipped)

Located just below the engine start/stop button, this button is used to change pump jet nozzle position and to adjust ride to suit watercraft load and water conditions.

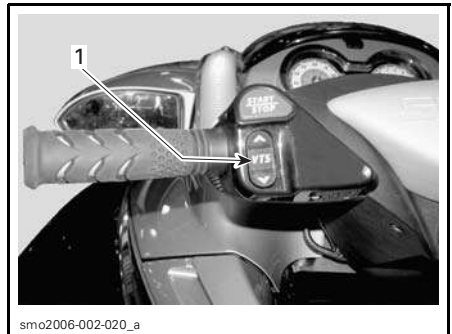

smo2006-002-020_a

TYPICAL

1. VTS button

A VTS position indicator is included in the information center gauge. See *INFORMATION CENTER* in this section.

6) Shift Lever

A push-pull lever:

- forward
- neutral
- reverse.

WARNING

Shift lever should only be used when the engine is idling and watercraft is completely stopped. Do not use as a grab handle.

WARNING

Only use reverse at slow speed and for the shortest time possible. Always ensure the path behind is clear of objects and persons including children playing in shallow water.

CAUTION: Never rev the engine at high RPM in reverse.

From the forward position, pull the lever to reverse. Push back to go to forward. Always set in forward when finished. To find the neutral, set in reverse then push back until the watercraft stops moving backwards.

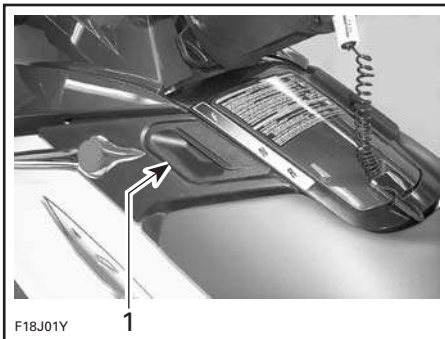

TYPICAL
1. Forward position

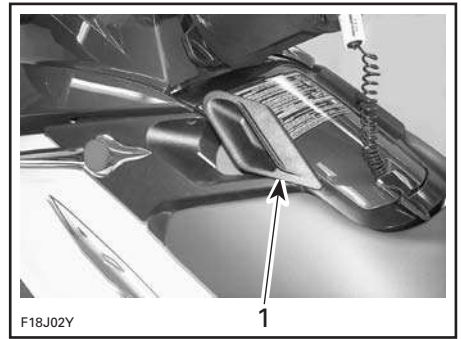

TYPICAL
1. Neutral position

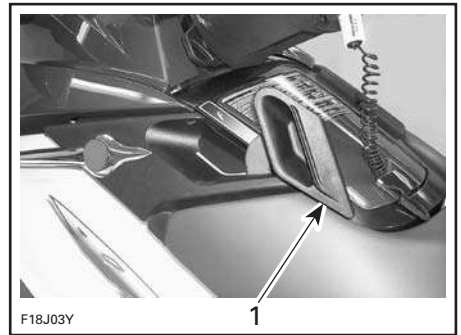

TYPICAL
1. Reverse position

7) Information Center Gauge

This is a multifunction gauge that supplies several real time useful information to the driver either in English, French or Spanish. See an authorized Sea-Doo dealer for unit settings.

At start-up, all LCD segments and indicator lights will turn on for 3 seconds each time the information center is activated (when safety lanyard is installed). This allows the driver to validate they are all working properly.

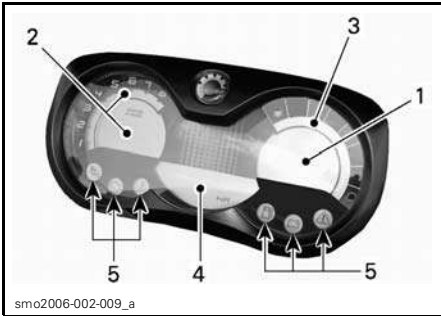

GTI MODELS

1. Speedometer
2. Tachometer
3. Fuel level
4. Information display
5. Indicator lights

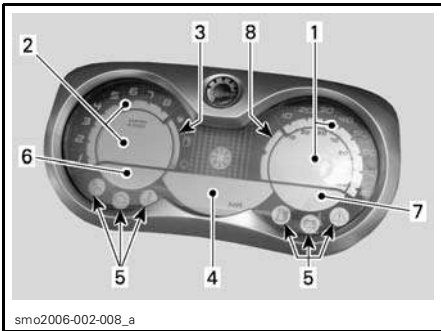

OTHER MODELS

1. Speedometer
2. Tachometer
3. Fuel level
4. Information display
5. Indicator lights
6. Water depth display
7. Water temperature display
8. VTS position indicator

1) Speedometer

Speedometer indicates the speed of watercraft in miles per hour (MPH) or kilometers per hour (km/h).

2) Tachometer

Tachometer indicates the revolutions per minute (RPM) of the engine. Multiply by 1000 to obtain the actual revolutions.

3) Fuel Level

Bar gauge continuously indicates the amount of fuel in the fuel tank while riding. A low-fuel condition is also indicated on the information display as only one bar is displayed. See *MES-SAGE DISPLAY* below.

4) Information Display

Compass

Displays the cardinal points to indicate the orientation of the watercraft.

WARNING

Use the compass as a guide only. Not to be used for navigation purposes.

GTI Models Only

Water Temperature (if so equipped)

Displays the water temperature of the water surface in degrees Celsius (°C) or Fahrenheit (°F).

NOTE: Water temperature and depth gauge will be displayed alternately.

Water Depth (if so equipped)

Display the water depth under the hull within 0 to 50 meters (0 to 170 feet).

NOTE: Under certain conditions, the gauge may stop displaying. The gauge ability to display the depth depends on the usage conditions.

WARNING

Never use the depth gauge as a warning device to ride in shallow water. Use it as a navigation guide only. Not to be used for navigation purposes.

NOTE: Water temperature and depth gauge will be displayed alternately.

All Models

Hourmeter (HR)

Displays the time in hours of the watercraft usage.

Message Display

Displays a message whenever one of the following circumstances occurs. The abbreviations between parenthesis here are the code displayed:

- engine or exhaust system overheating (EXHAUST or ENGINE)
- low oil pressure (OIL)
- low battery voltage (12 V LOW)
- high battery voltage (12 V HI)
- low fuel level (FUEL-LO)
- maintenance reminder (MAINT)

NOTE: When the watercraft is due for a maintenance inspection, the message MAINT will blink. After servicing, your authorized Sea-Doo dealer will clear it.

- check engine (CHK ENG)

NOTE: If a fault occurs, this system generates numbered fault codes (P-XXXX) that are displayed through the information center. In case of a failure, you may call your authorized Sea-Doo dealer and he would be able to assist you to obtain the code descriptions to help troubleshooting.

- sensor failure (vehicle electronic equipment) (SENSOR)
- invalid safety lanyard (KEY)
- safety lanyard, learning key active (L KEY)

A beeper will sound and indicator light will blink depending on the fault occurring to catch the driver attention when necessary.

Except for low liquid levels, which can be corrected by refilling, it is recommended to see an authorized Sea-Doo dealer when other messages occur.

5) Indicator Lights

NOTE: Refer to *INFORMATION DISPLAY* above for additional information regarding messages.

Low oil pressure (OIL)



Check engine (CHK ENG)



Engine or exhaust system overheating (H-TEMP)



Low fuel level (FUEL-LOW)



Low/high battery voltage (12 V LOW/HI)



Maintenance reminder (MAINT)



6) Water Depth Display (if so equipped)

All Except GTI Models

Displays the water depth under the hull within 0 to 50 meters (0 to 170 feet).

NOTE: Under certain conditions, the gauge may stop displaying. The gauge ability to display the depth depends on the usage conditions.

WARNING

Never use the depth gauge as a warning device to ride in shallow water. Use it as a navigation guide only. Not to be used for navigation purposes.

7) Water Temperature Display (if so equipped)

All Except GTI Models

Displays the water temperature of the water surface in degrees Celsius (°C) or Fahrenheit (°F).

8) VTS Position Indicator (if so equipped)

The VTS position indicator shows the riding attitude of the watercraft.

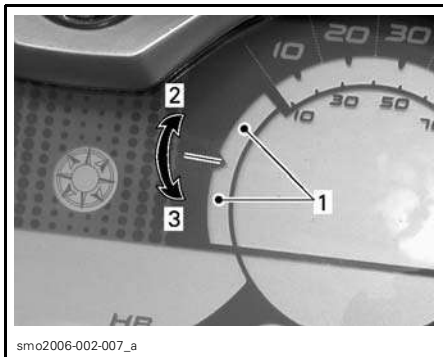

1. Position indicator
2. Bow up
3. Bow down

8) Glove Box

A small, convenient storage compartment for personal articles.

GTI Models

For easier access inside glove box, open and pull on cover.

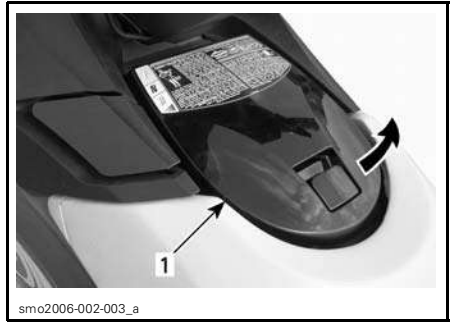

OPEN COVER

1. Glove box cover



PULL ON COVER

9) GPS Receiver (Global Positioning System) (if so equipped)

A removable GPS receiver located on the glove box cover.

The GPS receiver provides the watercraft position on earth.

Refer to manufacturer's documentation supplied with the GPS receiver for proper use.

WARNING

Reading the GPS receiver can distract from the operation of the watercraft, particularly from constantly scanning the environment. This could lead to a collision resulting in severe injuries or death. Before reading the GPS receiver, ensure your environment is clear and free from obstacle, and bring the watercraft to a low speed. Additionally, make sure to often double-check for obstacles.

WARNING

Remember, the data provided by the GPS receiver is for reference only. NEVER rely solely on this information for your safety.

CAUTION: To prevent weather damage or theft to your GPS receiver, always remove it from its receptacle when leaving the watercraft.

Push release button to remove GPS receiver.



To reinstall, position GPS receiver in its receptacle and push until it latches.



10) Fuel Tank Cap

Open the front storage compartment cover to expose fuel tank cap.

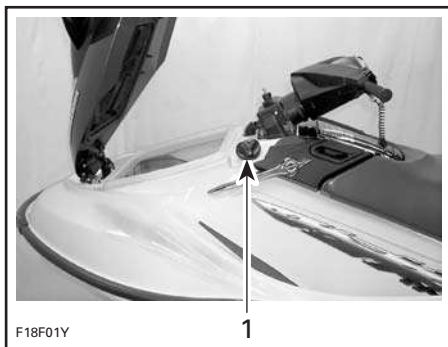

TYPICAL

1. Fuel tank cap

Refer to the vehicle illustration for fuel tank cap location.

Unscrew the cap counterclockwise. After fueling, reinstall cap and fully tighten.

WARNING

Always stop the engine before refueling. Fuel is flammable and explosive under certain conditions. Always work in a well ventilated area. Do not smoke or allow open flames or sparks in the vicinity. Fuel tank may be pressurized, turn cap slowly when opening. Never use an open flame to check fuel level. When fueling, keep watercraft level. Do not overfill or top off the fuel tank and leave watercraft in the sun. As temperature increases, fuel expands and might overflow. Always wipe off any fuel spillage from the watercraft. Periodically verify fuel system.

11) Front Storage Compartment Cover

It gives access to the front storage compartment. Always relatch cover after closing.

Front Storage Compartment

A convenient watertight area (removable basket on some models) to carry personal articles. Ideal location for towrope, first aid kit, etc.

WARNING

Never leave any heavy or breakable objects loose in the storage area/basket. Never operate the watercraft with any storage compartment cover open.

GTI Models

CAUTION: Never operate the watercraft without storage compartment properly installed, water might enter and fill the bilge.

Spare Spark Plug Holder

The storage basket cover features a spare spark plug holder.

To keep spare spark plugs dry and prevent shocks that might break them or affect their adjustment, store spark plugs in this holder.

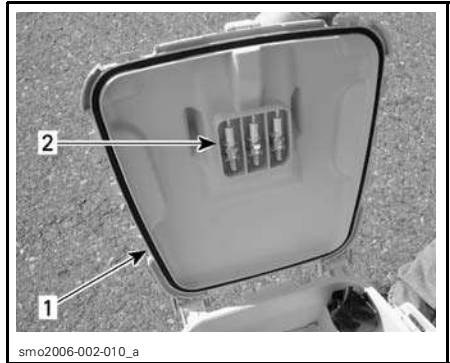

1. Storage basket cover
2. Spark plug holder

NOTE: Adjust spare spark plug gap according to *SPECIFICATIONS* before installation.

NOTE: Spare spark plugs are not supplied with the watercraft.

RXP Models

WARNING

Never store or carry anything underneath basket.

All Models Except RXP and GTI

If there is water in the storage area, pull out the drain plug to let water go out. Reinstall the plug when done.



1. Drain plug

NOTE: The water will flow to the bilge. If there is an important quantity of water, ensure to drain the bilge prior to using the watercraft.

The front storage area includes a latch to hold an approved fire extinguisher (sold separately).

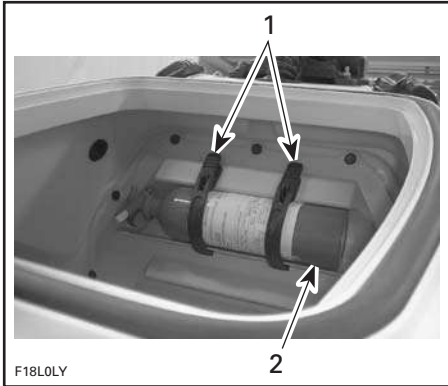

- TYPICAL**
1. Retaining straps
2. Extinguisher (sold separately)

⚠ WARNING

Ensure to properly secure extinguisher with the supplied retaining straps.

Some models feature a removable basket. Its handle is convenient to carry personal objects.

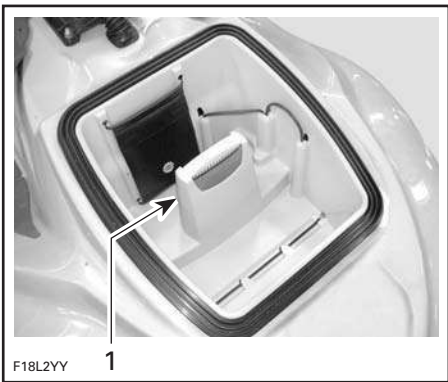

- TYPICAL**
1. Removable basket

Some models may have convenient rubber bands and other useful accessories.

RXP Models

Lift the basket to get access to the holder for an approved fire extinguisher (sold separately). It also contains the Operator's Guide and the tool kit.



12) Front Storage Compartment Cover Latch

Pull the latch lever upward in order to open the front storage compartment cover. Always relatch.

NOTE: Verify periodically the lock pin tightness of storage cover. Tighten if needed and make sure storage cover latches properly.

13) Tool Kit

The tool kit contains tools needed to perform basic watercraft maintenance.

RXP Models

It is located in the front storage compartment inside the holder for the fire extinguisher. See *FRONT STORAGE COMPARTMENT* above.

GTI Models

It is located in the front storage compartment.

Other Models

It is located under the seat extension.

14) Air Intake Opening

This is where air enters to supply the engine and to ventilate the engine compartment. If the air intake opening is kept under water, water will get inside bilge.

CAUTION: If the air intake opening is kept under water, such as turning constantly in tight circles, water will get inside bilge, which may cause severe damage to internal parts of the engine.

15) Seat Strap

The seat strap provides a handhold to assist boarding and is used as a handhold for the passenger.

NOTE: On RXP Models, the seat strap is available when the seat cover is removed.

16) Seat Extension Latch (if so equipped)

Removing the seat extension allows access to the rear storage basket. It also gives access to the seat latch.

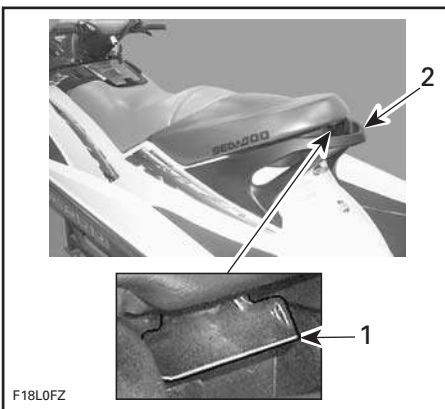

TYPICAL

1. Seat extension latch
2. Rear grab handle

17) Seat Latch

Removing the seat allows access to the engine compartment.

The seat latch is located at the rear end and underneath the seat.

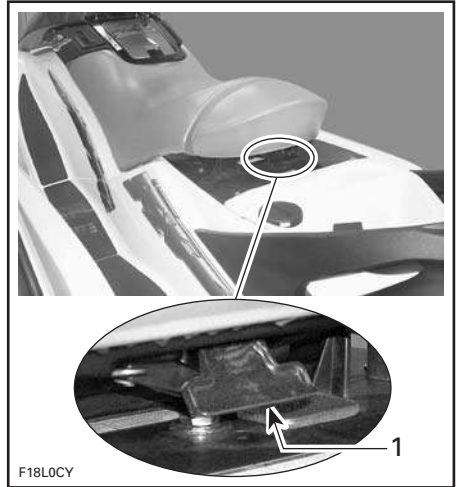

TYPICAL

1. Seat latch

To remove seat, pull the latch lever upward and hold. Lift and pull the seat rearward.

NOTE: On some models, it is necessary to remove the seat extension first.

To latch seat, align latch hole with pin then, firmly push down on the rear portion of the seat.

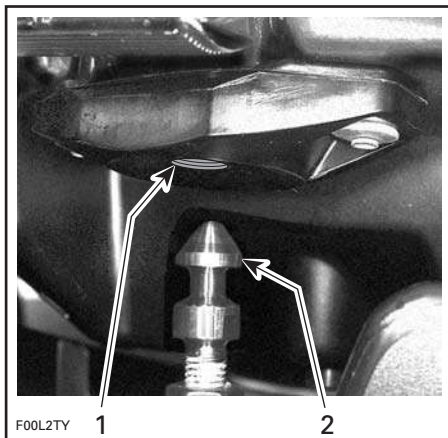

1. Latch hole
2. Pin

Engine Compartment

Removing the seat gives access to the engine, electrical and fuel systems.

⚠ WARNING

Certain components in the engine compartment may be very hot. Direct contact may result in skin burn. When starting or operating the engine, do not touch any electrical part. Never leave any object, rag, tool, etc., in the engine compartment or in the bilge.

18) Seat Cover (if so equipped)

⚠ WARNING

Never sit on the seat cover.

The seat cover allows to install a number on its side panels. It is removable to expose the seat for a passenger.

To remove cover:

Unlatch and pull seat out.

Unlock the quarter-turn screws.



Pull cover tabs each side of seat then remove cover.

Install seat and properly relatch.

To reinstall cover:

Unlatch and pull seat out.

Position rear of cover in place without inserting front tabs yet.

Carefully pull tabs outward each side of seat and insert cover in place.

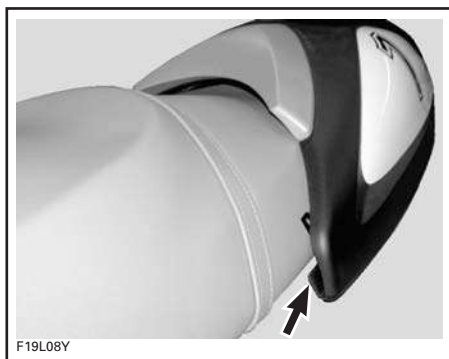

Finish pushing cover in position then lock the quarter-turn screws.

Install seat and properly relatch.

19) Rear Grab Handle

Provides a handhold for boarding when needed and a handhold for the passenger or the spotter. See illustration above.

CAUTION: Never use the grab handle to tow anything or to lift the watercraft.

20) Rear Storage Basket (if so equipped)

A convenient watertight, removable basket to carry personal articles.

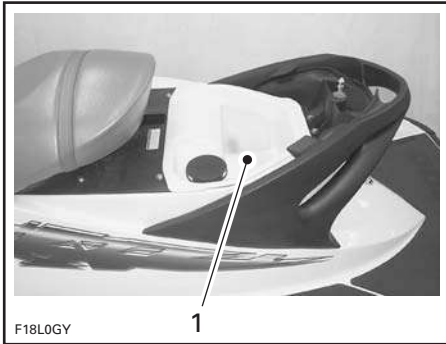

1. Rear storage basket

Spare Spark Plug Holder

The storage basket features a spare spark plug holder.

To keep spare spark plugs dry and prevent shocks that might affect the adjustment or break them, a holder is provided.

Unscrew cap counterclockwise to expose the holder and insert spark plug in their holes. Reinstall cap.

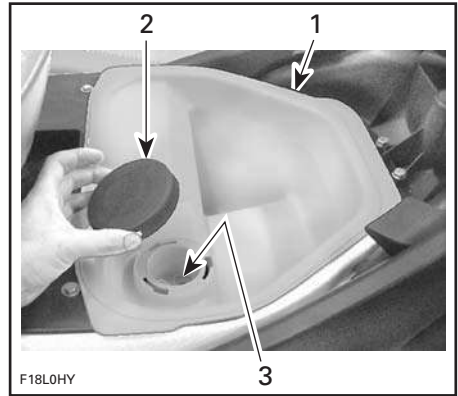

1. Storage basket
2. Spare spark plug holder cap
3. Spark plug holder

NOTE: Adjust spare spark plug gap according to *SPECIFICATIONS* before installation.

NOTE: Spare spark plugs are not supplied with the watercraft.

21) Front and Rear (bow/stern) Eyelets

Front (bow) Eyelet

Eyelets can be used for mooring, towing and as a tie-down point during trailering.

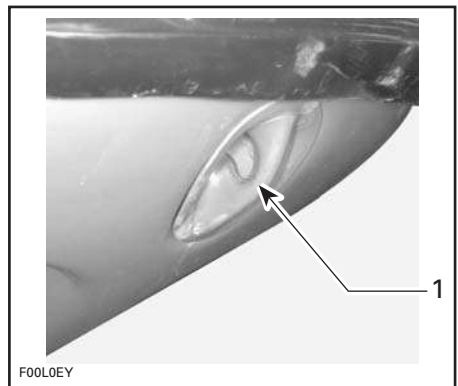

1. Front (bow) eyelet

Rear (stern) Eyelet

All Models Except RXP

This eyelet allows a rope with a hook, a closed end or an open end to be attached.

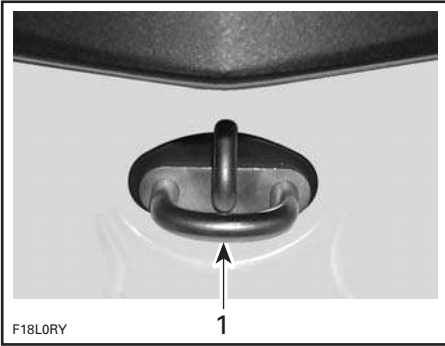

1. Rear (stern) eyelet

RXP Models

3 eyelets are available for your convenience.

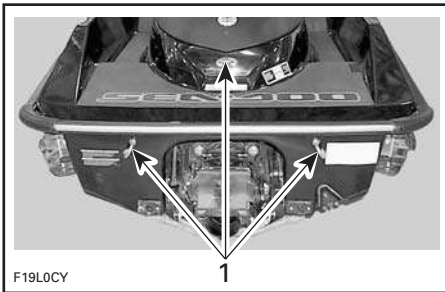

1. Eyelets

22) Mooring Cleats

These cleats can be temporarily used for docking, while refueling for example.

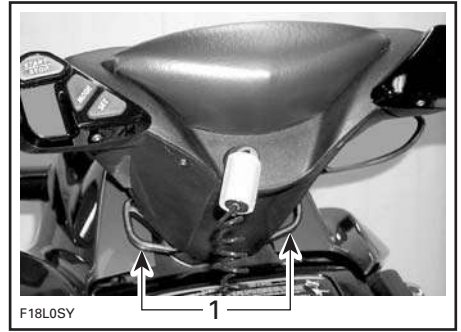

TYPICAL

1. Mooring cleats

CAUTION: Never use mooring cleats to pull or lift the watercraft.

23) Footboard

User's feet should rest on the footboard when riding.

24) Boarding Pads

Provide a cushioned surface for the knees when boarding from rear of watercraft.

25) Boarding Platform

Provides a large surface for easier boarding from rear of watercraft.

26) Boarding Step (if so equipped)

A convenient step to help reboarding the watercraft.

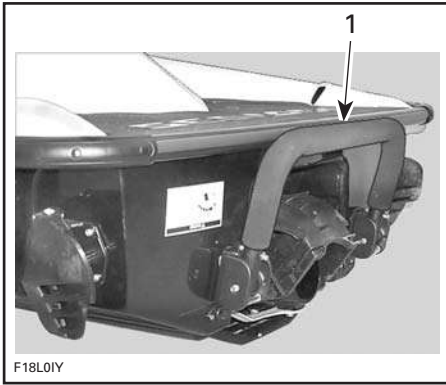

TYPICAL
1. Boarding step

Pull down the step with your hand and hold until a foot or a knee is put on the step.

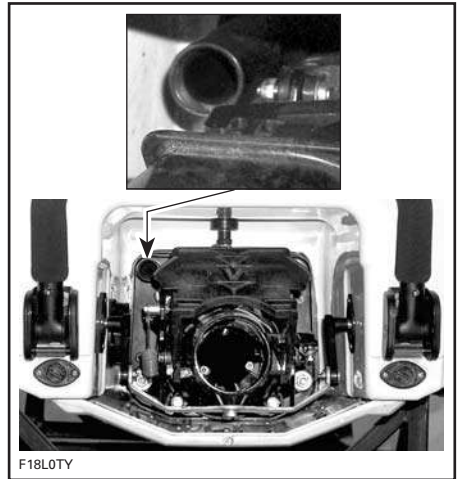

ALL MODELS EXCEPT RXP

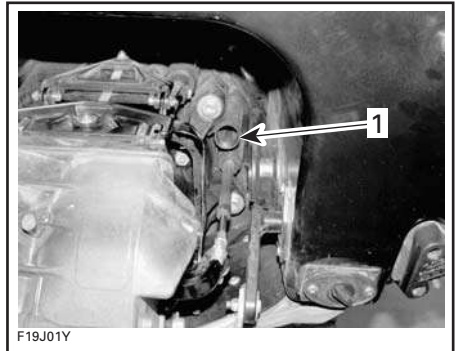

RXP MODELS
1. Flushing connector

27) Flushing Connector

A convenient connector is provided to allow easy installation of a garden hose to flush the exhaust cooling system.

⚠ WARNING

When operating the engine while the watercraft is out of the water, the heat exchanger in the ride plate may become very hot. Avoid any contact with ride plate as burns may occur.

On some models, an additional flushing connector is located in engine compartment to allow flushing while watercraft is on a lift or if you prefer to flush from this location, either flushing connector can be used to flush the exhaust cooling system. Remove seat to gain access.

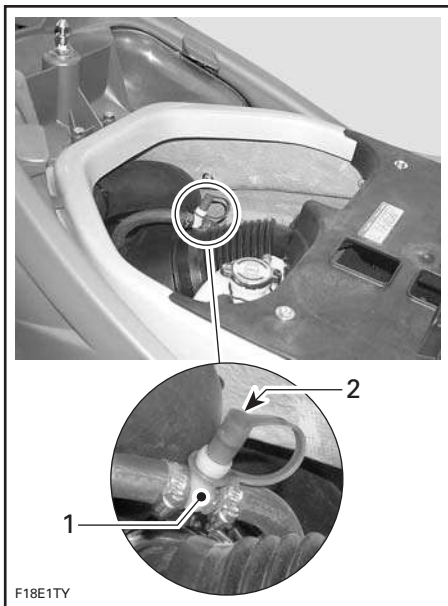

SOME MODELS

1. Flushing connector
2. Dust cap

Refer to *POST-OPERATION CARE* section for proper use.

28) Bilge Drain Plugs

Drain plugs have two functions:

- Should water be found in the bilge, it can be easily drained by unscrewing the drain plugs when engine is off and watercraft is out of water
- Drain plugs use a low pressure area in the jet pump to siphon the water out of the bilge when the engine is operating. Inspect each pick-up screen for obstructions, clean as necessary.

CAUTION: Remove watercraft from water prior to unscrewing drain plugs.

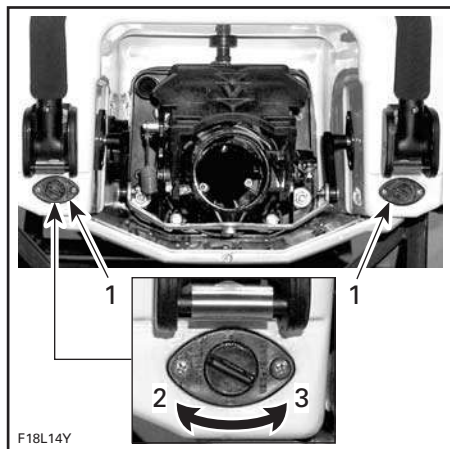

TYPICAL

1. Drain plugs
2. Tighten
3. Unscrew

Tilt the watercraft slightly to the rear so that the water can completely flow out of the bilge.

It is suggested to drain bilge on a ramp.

CAUTION: Make sure drain plugs are properly secured prior to launching the watercraft in water.

29) Jet Pump Nozzle

Jet pump nozzle turns side to side via rider input at the handlebar. This provides directional control when engine is running.

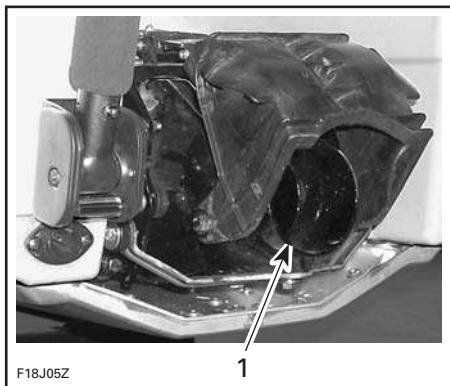

TYPICAL
1. Jet pump nozzle

30) Reverse Gate

When selecting the neutral or reverse position with the shift lever, the reverse gate moves up or down to obtain the desired position.

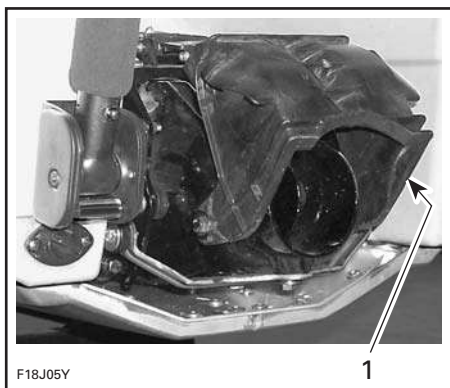

TYPICAL
1. Reverse gate

31) Jet Pump Water Intake and Ride Plate

The water is drawn up by the impeller through this opening. The water intake grate minimizes the entry of foreign objects into the propulsion system.

NOTE: The ride plate is the heat exchanger for the ENGINE cooling system.

⚠ WARNING

Keep away from intake grate while engine is on. Items such as long hair, loose clothing or personal flotation device straps can become entangled in moving parts resulting in severe injury or drowning.

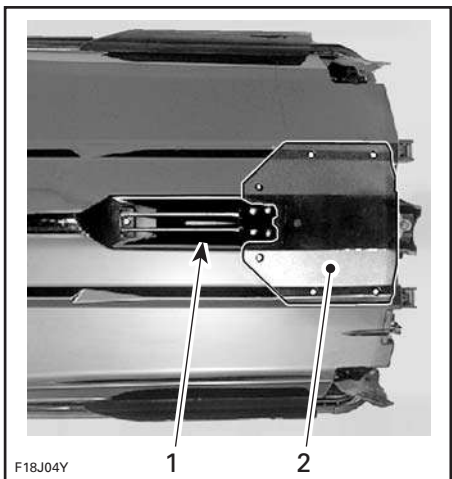

TYPICAL
1. Water intake
2. Ride plate

⚠ WARNING

When operating the engine while the watercraft is out of the water, the heat exchanger in the ride plate may become very hot. Avoid any contact with ride plate as burns may occur.

32) Fuses

All Models Except RXP

Fuses are located under the seat in the bilge. Refer to *MAINTENANCE* for more details.

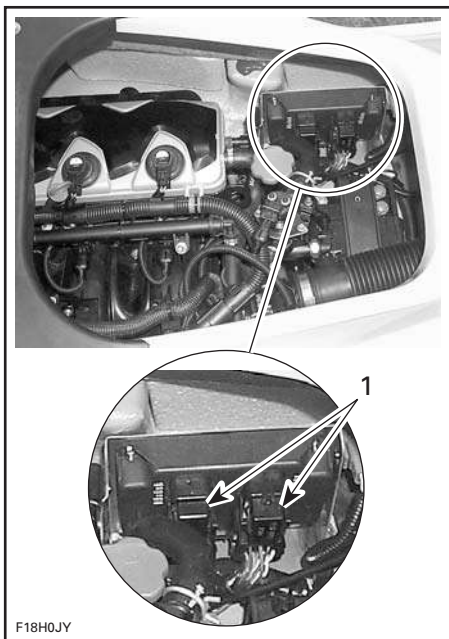

F18H0JY

TYPICAL
1. Fuses

RXP Models

Fuses are located under basket in front storage compartment. Refer to *MAINTENANCE* for more details.

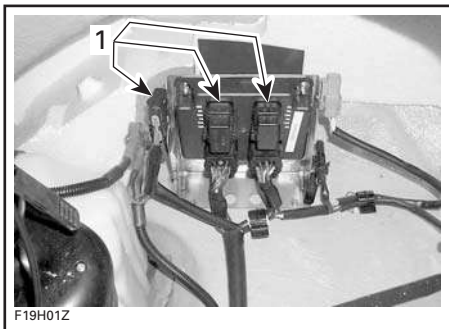

F19H01Z

1. Fuses

33) Battery

All Models Except RXP

Battery is located under seat in bilge. Refer to *SPECIAL PROCEDURES*.

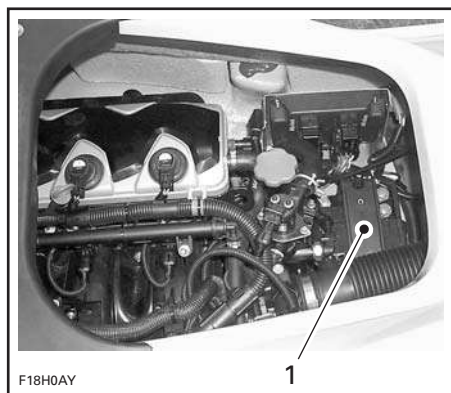

F18H0AY

TYPICAL
1. Battery

RXP Models

Fuses are located under basket in front storage compartment. Refer to *SPECIAL PROCEDURES*.

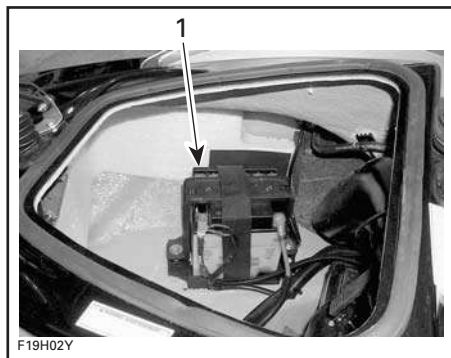

F19H02Y

1. Battery

34) Side Vanes

Side vanes are part of the Off-Power Assisted Steering (O.P.A.S.™) system.

The side vanes assist the steering system.

Models with Sliding Side Vanes

When engine RPM is reduced, the side vanes are lowered to assist the steering system. Refer to *PRINCIPLE OF OPERATION* in *OPERATING INSTRUCTIONS* section for the description of the system.

All Models

⚠ WARNING

Check handlebar and corresponding side vanes operation before starting. Never use side vanes as a supporting point to board the watercraft or to lift it. Never turn handlebar while someone is nearby rear of watercraft. Keep away from steering moving parts (nozzle, side vanes, linkage etc.).

35) Engine Oil Dipstick

Located in engine compartment, on the engine. It indicates the engine oil level.

⚠ WARNING

Certain components in the engine compartment may be very hot. Direct contact may result in skin burn.

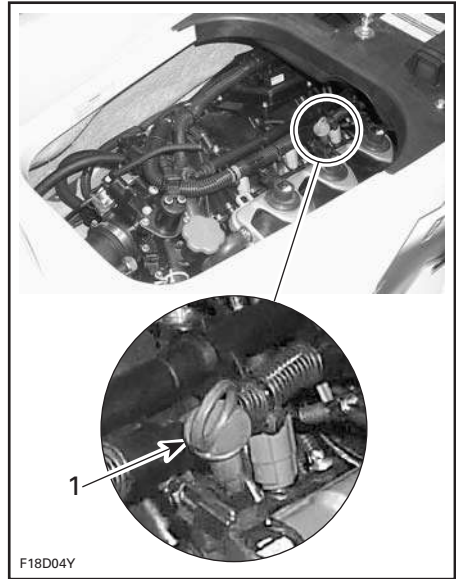

TYPICAL — ALL MODELS EXCEPT RXP
1. Oil dipstick

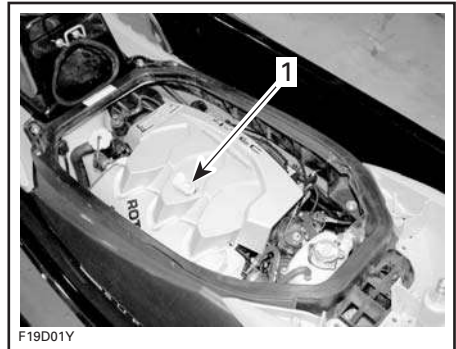

RXP MODELS
1. Oil dipstick

Refer to *LIQUIDS* for more details.

36) Engine Oil Filling Cap

Located in engine compartment, on the engine. It allows adding oil in the engine when required.

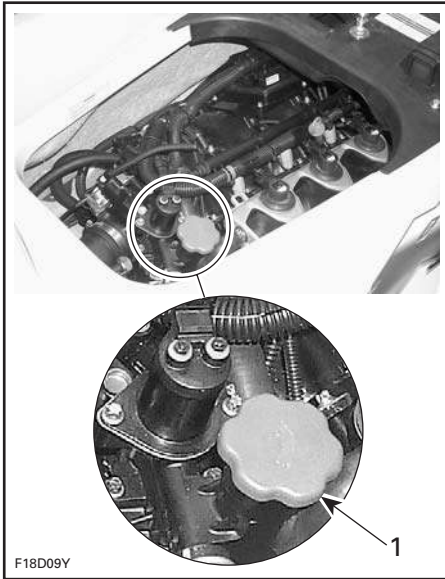

F18D09Y

TYPICAL — ALL MODELS EXCEPT RXP
 1. Oil filling cap

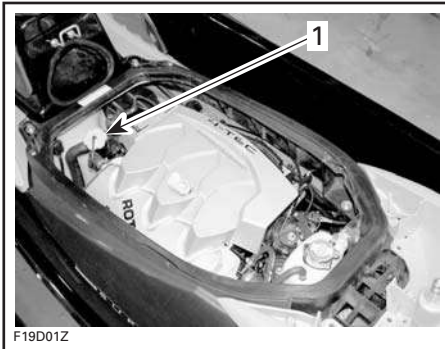

F19D01Z

RXP MODELS
 1. Oil filling cap

Refer to *LIQUIDS* for more details.

37) Cooling System Expansion Tank Cap

Located in engine compartment. It provides access to the expansion tank filling neck.

⚠ WARNING
 Certain components in the engine compartment may be very hot. Direct contact may result in skin burn.

Remove seat extension and storage basket to expose expansion tank.

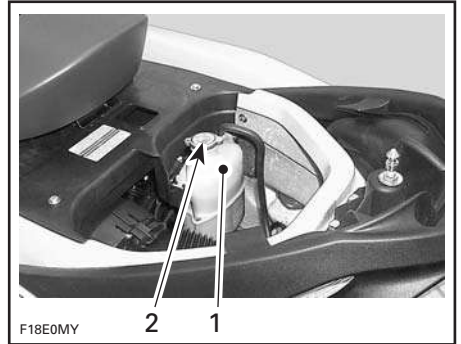

F18E0MY

TYPICAL — ALL MODELS EXCEPT RXP
 1. Expansion tank
 2. Cap

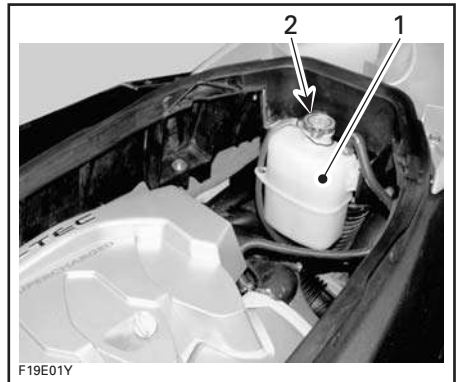

F19E01Y

RXP MODELS
 1. Expansion tank
 2. Cap

Refer to *LIQUIDS* for more details.

38) Ski/Wakeboard Post (if so equipped)

Pull up the post to hook up a ski or wakeboard rope. Push down when finished and lock in properly.

To lift post, unlock by pulling the locking pin then lift post. Ensure it is properly locked. Lowering the post is the opposite operation.

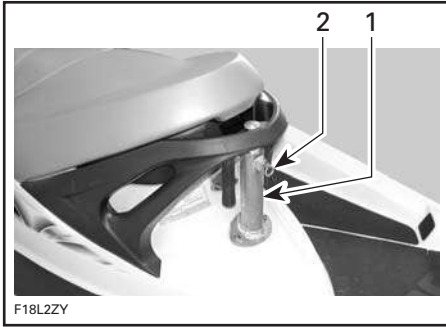

1. Ski/wakeboard post
2. Pull locking device to unlock

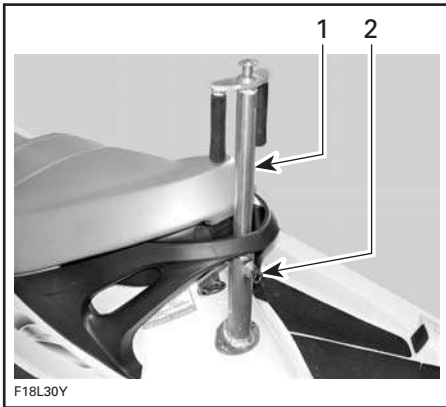

1. Ski/wakeboard post lifted
2. Ensure it is locked

WARNING

Make sure ski/wakeboard post is fully extended and locked before use. Completely retract and lock when not used. Use caution with skier/wakeboarder in tow as tow rope may backlash to watercraft when released. Never perform a sharp turn when towing a skier, wakeboarder or any toy.

Always have one person other than the operator as an observer.

NOTE: The handles are supplied for the observer to have a grip when watching.

CAUTION: Never use the ski/wakeboard post to tow other crafts.

39) Wakeboard Rack (if so equipped)

Convenient removable rack(s) to carry wakeboard(s).

To install:

- Position rack on bumper trim with its centerline in between the buckle receivers located in the footwell area.
- Position the 2 outer J-hooks of the rack so as to grab the fiberglass lip of the hull underneath the bumper trim.

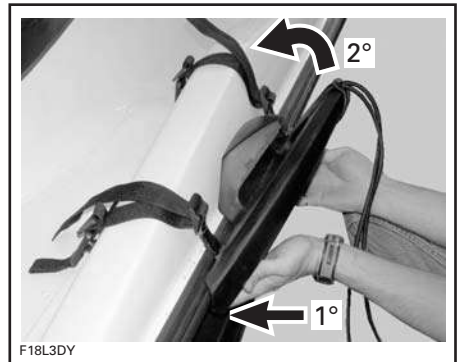

- Attach the male buckles onto the buckle receivers located in the footwell.



F18L3EY

- Tighten the straps by firmly pulling upwards.



F18L3FY

- Double-check that rack is properly installed by giving it a tug.

⚠ WARNING

If rack is not properly secured on the watercraft, it could become loose and detach unexpectedly, creating a risk of injury to people nearby. To avoid:

- Ensure straps are in good condition.
- Secure rack properly on watercraft.
- Periodically check that straps are tight.

- When installing a wakeboard on the rack, position wakeboard fin(s) outward then secure bungee cords to tightly hold wakeboard.

⚠ WARNING

To avoid possible injuries and cuts from wakeboard's fin(s), always place FIN(S) OUTWARDS.



F18L3GY

1. Fin outward



F18L3HY

- After installation, pull and push wakeboard to ensure it is tightly secured to rack.

WARNING

If wakeboard is not properly secured on rack, it could become loose and detach unexpectedly, creating a risk of injury to people nearby. To avoid:

- Inspect bungee cords condition and replace if damaged.
- Secure wakeboard properly on rack.
- Periodically check that board is properly attached.



NOTE: When wakeboard is removed from its rack, secure bungee cords so that they will not move freely when riding watercraft.



CAUTION: The rack is designed to hold one wakeboard. Do not use to hold more than one wakeboard or to transport ski or any other object. Do not use rack(s) as mooring points or to reboard.

WARNING

With wakeboard and/or rack installed, operate with extra caution:

- NEVER perform aggressive maneuvers including spin-out.
- NEVER jump waves
- Use common sense and limit speed.

Otherwise, wakeboard could detach or occupants could fall off and get injured against the wakeboard or rack.

WARNING

When trailering the watercraft, NEVER leave a wakeboard installed on the rack. Otherwise, wakeboard fin(s) could cause injury to bystanders or wakeboard could fly off on the road. The bungee cords are under tension and could spring back and whip someone when released. Use caution.

Removal is reverse of installation.

LIQUIDS

CAUTION: Scrupulously follow the instructions of this section. Failure to do so may reduce the engine's life and/or performance.

Fueling Procedure

WARNING

Follow these safe boating fueling instructions meticulously.

Turn off engine.

Do not allow anyone to remain on the watercraft.

Tie watercraft securely to the fueling pier.

Have a fire extinguisher close at hand.

Do not insert the spout too far in filler neck.

Pour fuel slowly so that air can escape from the tank and prevent fuel flow-back. Be careful not to spill fuel.

Stop filling when the fuel reaches the bottom of filler neck. Do not fill into the filler tube to prevent fuel spill out. Do not overfill. Fully tighten fuel tank cap.

WARNING

Always stop the engine before refueling. Fuel is flammable and explosive under certain conditions. Always work in a well ventilated area. Do not smoke or allow open flames or sparks in the vicinity. Fuel tank may be pressurized, turn cap slowly when opening. Never use an open flame to check fuel level. When fueling, keep watercraft level. Do not overfill or top off the fuel tank and leave watercraft in the sun. As temperature increases, fuel expands and might overflow. Always wipe off any fuel spillage from the watercraft. Periodically verify fuel system.

Recommended Fuel

Naturally-Aspirated Engines Models

Use regular unleaded gasoline with the following recommended minimum octane number.

LOCATION	OCTANE NUMBER
Inside North America	87 octane (RON + MON)/2
Outside North America	91 RON

Supercharged and Supercharged Intercooled Engines Models

It is recommended to use a premium unleaded gasoline with the following octane number for optimum performance.

LOCATION	OCTANE NUMBER
Inside North America	91 octane (RON + MON)/2
Outside North America	95 RON

As a minimum, regular unleaded gasoline with the following minimum octane number may be used.

LOCATION	OCTANE NUMBER
Inside North America	87 octane (RON + MON)/2
Outside North America	91 RON

All Models

CAUTION: Never experiment with other fuels or fuel ratios. Never use fuel containing more than 10% alcohol, (ethanol or methanol). The use of non-recommended fuel can result in watercraft performance deterioration and damage to critical parts in the fuel system and engine components.

Engine Oil

Recommended Oil

This watercraft features a 4-stroke engine that requires 4-stroke motor oil for internal engine lubrication. Ensure to respect the following requirements.

NA Engines

Watercraft featuring 4-stroke engines without superchargers require 4-stroke motor oil meeting the requirements for API service classification SL, SJ or SH. Always check the API service label on the oil container to be sure it includes those letters.

The XP-S 10W-40 4-stroke oil (P/N 219 700 346) sold by authorized Sea-Doo dealers meets those requirements.

NOTE: A synthetic oil meeting the same requirements may be used. The XP-S 5W-40 Synthetic 4-stroke oil (P/N 293 600 039) is suitable.

Supercharged and Supercharged Intercooled Engines

Use the XP-S 10W-40 4-stroke oil (P/N 219 700 346) or an equivalent approved by BRP. The same oil lubricates both the engine and the supercharger clutch. The XP-S 10W-40 4-stroke oil (P/N 219 700 346) has been thoroughly tested to be free of any additives that could impair the functionality of the supercharger clutch.

NOTE: Use of any oil that is not recommended may void BRP's limited warranty.

CAUTION: NEVER use synthetic oil in these engines. This would impair the proper operation of the supercharger clutch. Do not add any additives to the recommended oil. Beware that oils not recommended by BRP may contain additives (friction modifiers) that may cause inappropriate slippage of the supercharger and eventually lead to premature wear. For this reason, oils other than XP-S 10W-40 4-stroke oil (P/N 219 700 346) or an approved equivalent are not recommended.

All Engines

CAUTION: Never use any 2-stroke engine oil.

Oil Viscosity

The same oil is recommended for all seasons and all ambient temperatures.

Oil Level

CAUTION: Check level frequently and refill if necessary. Do not overfill it would make the engine smoke and reduce its power. Operating the engine with an improper level may severely damage engine. Wipe off any spillage.

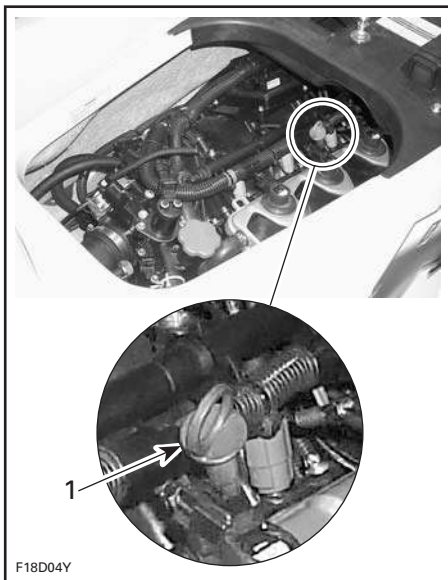

F18D04Y

TYPICAL
1. Dipstick

Check the oil level as follows:

NOTE: Before checking the oil level on this engine, it is necessary to warm-up engine and to let it idle for 30 seconds before shutting it off. Thereafter it is necessary to wait 30 seconds. Then, the oil can be checked. This is required to allow the oil to properly level in the different oil chambers. Otherwise, you will have a false oil level reading.

- Watercraft must be level. Check oil level either with watercraft in water or out of water. Engine should be warm.

CAUTION: Never run engine without supplying water to the exhaust cooling system when watercraft is out of water.

- If out of water, raise trailer tongue and block in position when bumper rail is level. Install a garden hose to the flushing connector. Refer to *FLUSHING* in *POST-OPERATION CARE* and follow the procedure.

CAUTION: Failure to flush exhaust cooling system, when engine is out of water, may severely damage engine and/or exhaust system.

- Warm-up engine then let idle for 30 seconds before stopping.
- Stop engine.
- Wait at least 30 seconds then pull dipstick out and wipe clean.

⚠ WARNING

Engine oil may be hot. Certain components in the engine compartment may be very hot. Direct contact may result in skin burn.

CAUTION: Never run engine longer than 5 minutes. Drive line seal has no cooling when watercraft is out of water.

- Reinstall dipstick, push in completely.
- Remove dipstick and read oil level. It should be between marks.

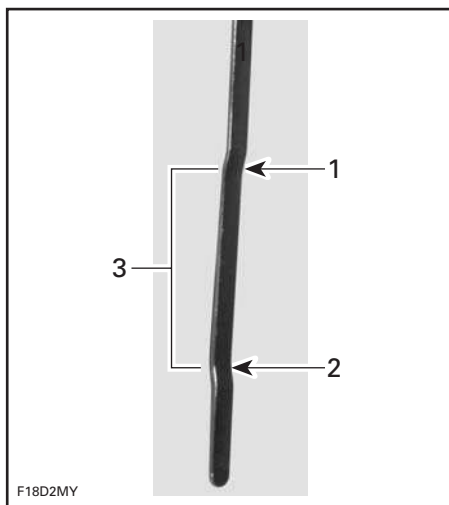

F18D2MY

1. Full
 2. Add
 3. Operating range
- Otherwise, add oil up to have the level between marks as required.

- To add oil, unscrew oil cap. Place a funnel into the opening and add the recommended oil to the proper level. Do not overfill.

NOTE: Every time oil is added in engine, the complete procedure explained above must be done (engine restarted, idling for 30 seconds, 30 seconds waiting time and then, rechecking the oil level). This is required to allow the oil to properly transfer in the different oil chambers and to then level. Otherwise, you will have a false oil level reading.

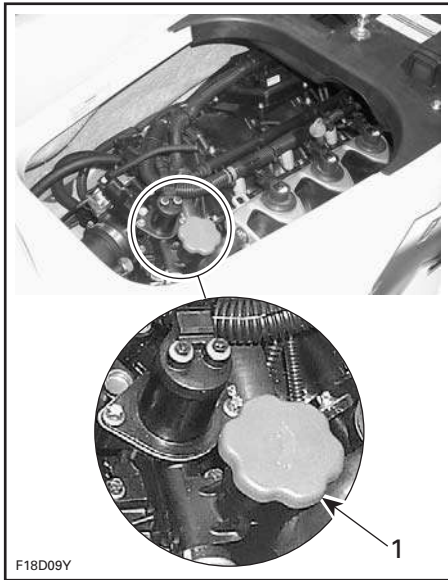

TYPICAL
1. Oil cap

- Properly reinstall oil cap and dipstick.

Engine Coolant

Recommended Coolant

Always use ethylene-glycol antifreeze containing corrosion inhibitors specifically for internal combustion aluminum engines.

NOTE: When available, it is recommended to use biodegradable antifreeze compatible with internal combustion aluminum engines. This will contribute to protect the environment.

Cooling system must be filled with water and antifreeze solution (50% demineralized water, 50% antifreeze).

BRP sells premixed coolant with freezing protection up to -37°C (-35°F) (P/N 293 600 038).

To prevent antifreeze deterioration, always use the same brand. Never mix different brands unless cooling system is completely flushed and refilled. Refer to an authorized Sea-Doo dealer.

Coolant Level

WARNING

Check coolant level with engine cold. Never add coolant in cooling system when engine is hot.

Remove seat extension to expose cooling system expansion tank.

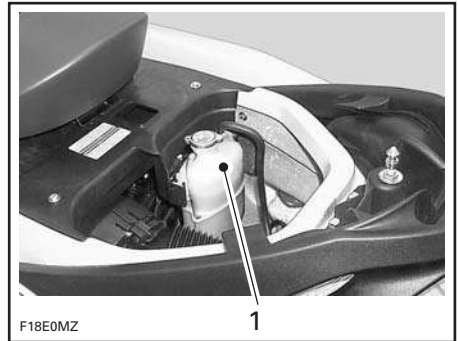

TYPICAL — ALL MODELS EXCEPT RXP
1. Expansion tank

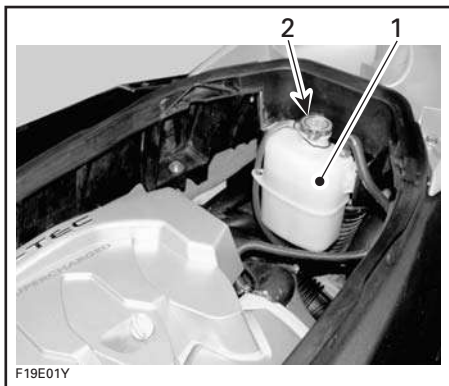

F19E01Y

RXP MODELS

1. Expansion tank
2. Cap

With vehicle on a level surface, liquid should be between MIN. and MAX. level marks of coolant reservoir when engine is cold.

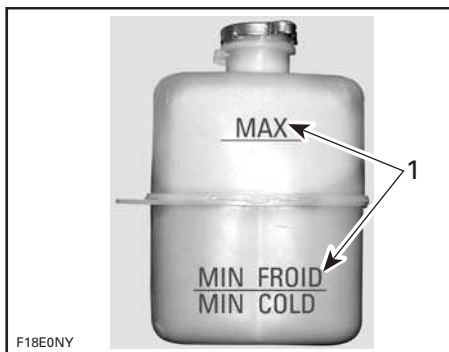

F18E0NY

1. Level between marks when engine is cold

NOTE: The watercraft is level when it is in water. When on a trailer, raise trailer tongue and block in this position when bumper rail is level.

Add coolant/demineralized water to have the level between marks as required. Use a funnel to avoid spillage. Do not overfill.

NOTE: Use a blend of 50% antifreeze with 50% demineralized water. Pre-mixed antifreeze/water is available (P/N 293 600 038) at your authorized Sea-Doo dealer.

NOTE: Using a blend of 40% antifreeze with 60% demineralized water will improve the cooling efficiency when watercraft is used in particularly hot weather and/or hot water condition.

Properly reinstall and tighten filler cap then reinstall seat extension.

NOTE: A cooling system that frequently requires coolant is the indication of leaks or engine problems. See an authorized Sea-Doo dealer.

Coolant Replacement

Refer to *MAINTENANCE* section.

BREAK-IN PERIOD

CAUTION: Scrupulously follow the instructions of this section. Failure to do so may reduce the engine's life and/or performance.

With Sea-Doo watercraft powered by Rotax® engines, a break-in period of 10 hours is required before continuous operation at full throttle.

To achieve a good break-in, throttle lever should not be depressed more than 3/4, however, brief acceleration and speed variations contribute to a good break-in.

CAUTION: Continued wide open throttle runs and prolonged cruising without speed variations should be avoided, this can cause engine damage during the break-in period.

NOTE: Never add oil in fuel tank during break-in period.

10-Hour Inspection

NOTE: The 10-hour inspection is at the expense of the watercraft owner.

It is highly recommended that after the first 10 hours of operation, the watercraft be checked by an authorized Sea-Doo dealer. This inspection will also provide the opportunity to discuss the unanswered questions you may have encountered during the first hours of operation.

PRE-OPERATION CHECKS

WARNING

The pre-operation check is very important prior to operating the watercraft. Always check the proper operation of critical controls, safety features and mechanical components, before starting as listed hereinafter. If not done as specified here, severe injury or death might occur. Bring all safety equipment required by local laws.

Some of the following items may not have been previously covered in this guide, however they will be described in the *MAINTENANCE* or *SPECIAL PROCEDURES* section. Please refer to these sections to have more detailed information.

WARNING

Engine should be off and the safety lanyard should always be removed from its post prior to verifying any of the following points. Only start watercraft once all items have been checked and operate properly.

ITEM	OPERATION	✓
Hull	Inspect.	
Jet pump water intake	Inspect/clean.	
Bilge	Drain. Ensure plugs are secured.	
Battery	Inspect tightness of cables and retaining fasteners.	
Fuel tank	Refill.	
Engine compartment	Check fuel line connections for tightness. Verify for any fuel leak/odor as well as oil and coolant leaks.	
Engine oil level	Check/refill.	
Engine coolant level	Check/refill.	
Steering system and side vanes (O.P.A.S.)	Check operation.	
Throttle system	Check operation.	
Shifter system	Check operation.	
VTS (if so equipped)	Check operation.	
Storage compartment covers and seat	Ensure they are closed and latched.	
Wakeboard(s) and rack(s)	<ul style="list-style-type: none"> – Ensure rack is installed properly. – Make sure bungee cords are in good condition. – Ensure wakeboard is installed properly. 	
Safety lanyard and engine start/stop button	Check operation.	
Water flow in exhaust manifold (only when temperature is below or close to freezing point)	Check if water properly flows in exhaust manifold.	

NOTE: See the detailed instructions hereinafter.

Hull

Inspect hull for cracks or damage.

Jet Pump Water Intake

Remove weeds, shells, debris or anything else that could restrict the flow of water and damage exhaust cooling system or propulsion unit. Clean as necessary. If any obstruction can not be removed, refer to an authorized Sea-Doo dealer for servicing.

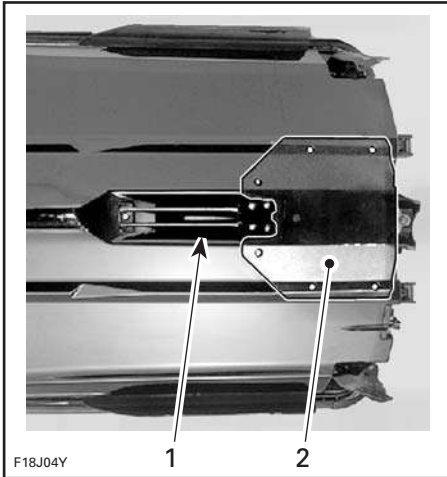

TYPICAL — INSPECT THESE AREAS

1. Water intake
2. Ride plate

Inspect leading edges of the impeller, if they have nicks or bends, performance will be greatly reduced.

Inspect for any possible coolant leak from ride plate.

⚠ WARNING

When operating the engine while the watercraft is out of the water, the heat exchanger in the ride plate may become very hot. Avoid any contact with ride plate as burns may occur.

Bilge

Should water be present in the bilge, tilt the watercraft to the rear and unscrew drain plugs to completely empty the bilge.

Secure bilge drain plugs.

⚠ WARNING

Make sure drain plugs are properly secured prior to launching the watercraft in water.

Battery

⚠ WARNING

Verify tightness of battery cables to their posts and condition of battery retaining fasteners. Do not charge or boost battery while installed.

Fuel Tank

With the watercraft horizontal, fill the fuel tank to specified level.

Check fuel tank retaining straps/fasteners.

Engine Compartment

⚠ WARNING

Should any leak or gasoline odor be present, do not start the engine. Refer to an authorized Sea-Doo dealer before use.

Engine Oil Level

Ensure oil level is appropriate as specified in *LIQUIDS* section. Check for oil leaks on engine and in engine compartment.

Engine Coolant Level

Ensure coolant level is appropriate as specified in *LIQUIDS* section. Check for coolant leaks on engine, in bilge and from ride plate.

WARNING

When operating the engine while the watercraft is out of the water, the heat exchanger in the ride plate may become very hot. Avoid any contact with ride plate as burns may occur.

Steering System

Assisted by another person, check steering operation for free movement. When the handlebar is horizontal, the jet pump nozzle should be in the straight ahead position. The rear edge of side vanes should be pointing outside of watercraft by approximately 20°. Ensure the jet pump nozzle and side vanes pivot easily and in the same direction as the handlebar.

WARNING

Check handlebar and corresponding steering nozzle operation before starting. Never turn handlebar while someone is nearby rear of watercraft. Keep away from steering moving parts (nozzle, side vanes, linkage etc.).

Throttle System

Check throttle lever for free and smooth operation. It should return to its initial position immediately after it is released.

WARNING

Check throttle lever operation before starting the engine.

Shifter System

Check reverse gate operation for free movement. With shift lever in forward position, the gate should be in upward position; and offering a resistance to go downward. With the shift lever in neutral position, gate should be in middle position. With shift lever in reverse position, gate should be in downward position.

WARNING

Verify the reverse gate operation before starting the engine.

VTS (Variable Trim System) (if so equipped)

Install safety lanyard then push arrows of VTS button to check nozzle movement. The VTS position indicator movement can also be seen in the information center.

Storage Compartment Covers and Seat

Ensure they are closed and latched.

WARNING

Make sure seat is securely latched.

Wakeboard Rack (if so equipped)

WARNING

Ensure rack is properly secured to watercraft body and that wakeboard is properly positioned and secured to rack prior to using watercraft. Ensure straps are in good condition.

Safety Lanyard and Engine Start/Stop Button

Position shift lever in neutral. Ensure that both switches operate properly. Start engine and stop it using each switch individually.

WARNING

Should the safety lanyard cap is loose or fail to remain on its post, replace it immediately in order to avoid unsafe use.

Water Flow in Exhaust Manifold (only when temperature is below or close to freezing point)

In Northern areas, if watercraft is to be used when temperature is below or close to freezing point (0°C (32°F)) or if watercraft was left unused while temperature was below or close to freezing point, water may be frozen in the supply hose going to the exhaust manifold. This could cause exhaust cooling system overheating. To ensure it is properly working, do the following prior to using the watercraft:

- The procedure is to be performed with watercraft out of water.
- Connect a garden hose to the flushing connector at jet pump.
- Perform the flushing operation as explained in *POST-OPERATION CARE*.
- Ensure water flows out of jet pump. Otherwise, water is frozen in supply hose and restricts water flow. Do not operate the watercraft in this condition.

NOTE: Pay attention that some water will also flow out of exhaust outlet. Make sure water is effectively flowing out of jet pump.

CAUTION: Operating watercraft with frozen water in supply hose might lead to engine components damage.

NOTE: When water freezes, no damage to engine components will occur as water expands but it may cause damage by preventing full flow of cooling water.

- Either wait until ice melt or pour some hot water on supply hose going to exhaust manifold. Then, perform the flushing operation again to make sure water properly flows out of jet pump. If you need assistance, refer to an authorized Sea-Doo dealer.

WARNING

Do not use any electrical heating device to heat the hose. Electrical devices may generate sparks that would ignite fuel vapors that might be present in the bilge causing a fire or an explosion.

- Ensure to drain bilge if water is present.

OPERATING INSTRUCTIONS

WARNING

Always perform the **PRE-OPERATION CHECKS** before operating the watercraft. Become thoroughly familiar with all controls and the function of each. Should any control or instruction not be fully understood, refer to an authorized Sea-Doo dealer.

Principle of Operation

Propulsion

The engine is directly coupled to a drive shaft which, in turn, rotates an impeller. This impeller is accurately adjusted in a housing where the water is drawn up from underneath the watercraft. Then the water flows through the impeller to a venturi. The venturi accelerates the water and produces thrust to move the watercraft. Depressing the throttle lever increases engine speed and therefore watercraft speed.



TYPICAL

WARNING

Whenever the engine is to be started, the operator and passenger(s) should always be properly sitting on the watercraft and be wearing protective clothing including a Coast Guard approved PFD and a wet suit bottom.

WARNING

Keep away from intake grate while engine is on. Items such as long hair, loose clothing or personal flotation device straps can become entangled in moving parts resulting in severe injury or drowning.

The shift lever should be in the forward position in order for the watercraft to advance.

Neutral and Reverse

WARNING

Never use jet pump components as a supporting point to board the watercraft. Shift lever should only be used when the engine is idling and watercraft is completely stopped. Never rev the engine at high RPM in reverse. Do not use reverse to stop the watercraft. Only use reverse at slow speed and for the shortest time possible. Always ensure the path behind is clear of objects and persons including children playing in shallow water.

To find the neutral, set in reverse then push back until the watercraft stops moving backwards.

The reverse gate will be in the middle position, directing half of the thrust toward the front of the watercraft to minimize watercraft movement.

WARNING

When the watercraft is in neutral position, the drive shaft and impeller are still turning.

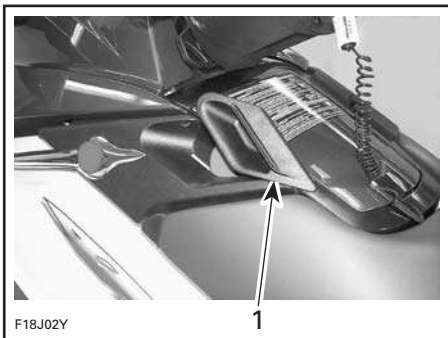

TYPICAL

1. Shift lever in neutral position

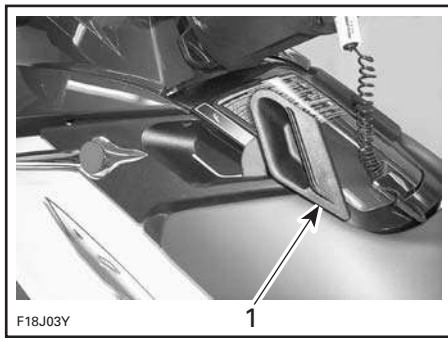

TYPICAL

1. Shift lever in reverse position

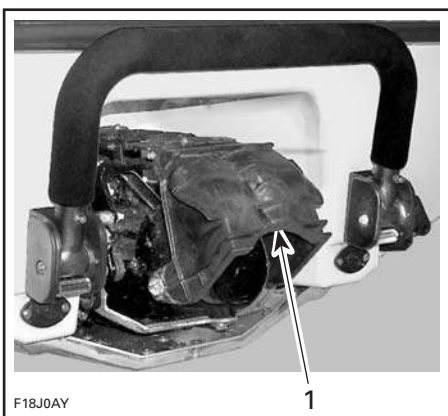

TYPICAL

1. Reverse gate in middle position

To obtain reverse, pull shift lever completely. The reverse gate will be in downward position, directing all the thrust toward the front of the watercraft.

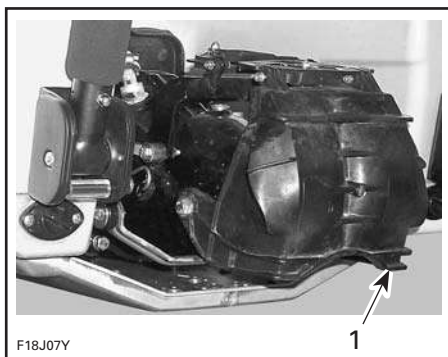

TYPICAL

1. Reverse gate in downward position

NOTE: To obtain maximum efficiency and control from the reverse, increase engine speed to slightly above idle. Too much RPM will create water turbulence and reduce reverse efficiency.

In reverse position, turn the handlebar in the same direction that you want to move the rear of the watercraft.

For example, to steer the rear of the watercraft to the left side, turn the handlebar to the left side.

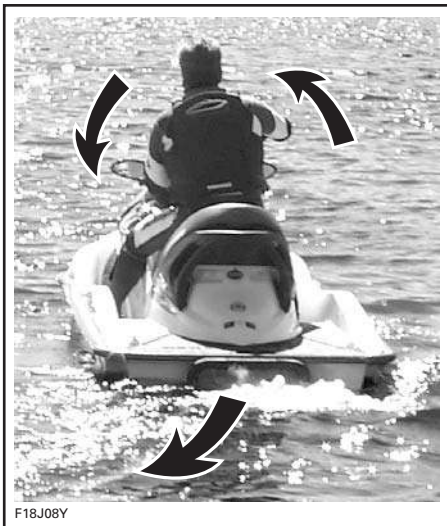

F18J08Y

WARNING

Shift lever should only be used when the engine is idling and watercraft is completely stopped. Do not use reverse to stop the watercraft.

RXP Models

Variable Trim System (if so equipped)

The variable trim system (VTS) changes the angle of the jet pump nozzle to provide the operator with a fast, effective system to compensate for load, thrust, riding position and water conditions. Correctly adjusted, it can improve handling, reduce porpoising, and position the watercraft at its best riding attitude to attain maximum performance.

When first using the watercraft, the operator should become familiar with the use of the variable trim system (VTS) at varying speeds and water conditions. A mid-range trim is generally used when cruising. Experience alone will dictate the best trim for the conditions. During the watercraft break-in period, when lower speeds are recommended, it is an excellent opportunity to gain familiarity of trim adjustment and its effects.

When the nozzle is positioned in an upward angle, the water thrust directs the bow of the watercraft upward. This position is used to optimize high speed.

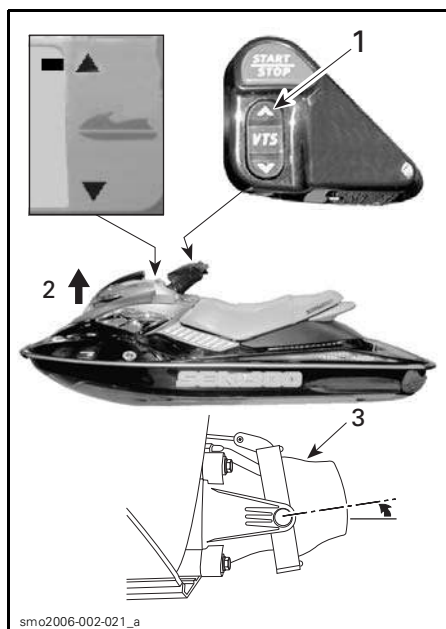

TYPICAL

1. Push on arrow pointing upward on VTS button
2. Bow up
3. Nozzle up

NOTE: VTS position is indicated on a bar gauge in the information center.

When the nozzle is directed downward, the bow is forced downward and enhances the watercraft turning capabilities. As with any watercraft, speed and operator body position and movement (body English), will determine the degree and sharpness of the watercraft turn. Porpoising can be reduced or eliminated if the nozzle is downward and speed is adjusted proportionately.

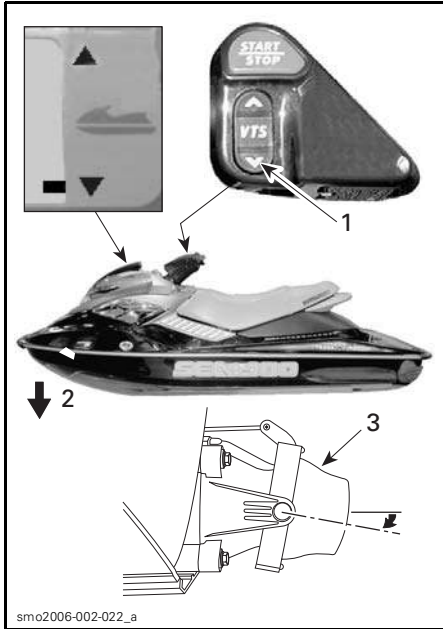

TYPICAL

1. Push on arrow pointing downward on VTS button
2. Bow down
3. Nozzle down

All Models

Steering



Turning the handlebar pivots the jet pump nozzle which controls the watercraft direction. Turning the handlebar to the right will turn the watercraft to the right and inversely. The throttle should be applied to turn the watercraft.

⚠ WARNING

Throttle should be applied and handlebar turned to change the direction of the watercraft. Steering efficiency will differ depending on the number of passengers, load, water conditions and environmental factors such as the wind.

Unlike a car, a watercraft needs some throttle to turn. Practice in a safe area applying the throttle and turning away from an imaginary object. This is a good collision avoidance technique.

⚠ WARNING

Directional control is reduced when the throttle is released and/or when engine is off.

The watercraft behaves differently with a passenger and requires greater skill. The passenger should always grip the seat strap or grab handle. Reduce speed and avoid sharp turns. Avoid choppy water conditions when carrying a passenger.

CAUTION: Combustion engine needs air to operate; consequently this watercraft can not be totally watertight. Any maneuvers such as figure eights etc., that cause the upper deck to be under water may cause severe engine problems due to water ingestion. Refer to *SPECIAL PROCEDURES* and *LIMITED WARRANTY* contained in this guide.

Off-Power Assisted Steering System (O.P.A.S.)

The Off-Power Assisted Steering (O.P.A.S.) system uses a dual side vanes design that assists the watercraft steering in deceleration, to redirect watercraft path when steering is turned after throttle has been released or engine stopped.

The side vanes on the rear sides of the hull, turn as the steering is turned to assist the watercraft turning. At first, carefully experiment turning with this system.

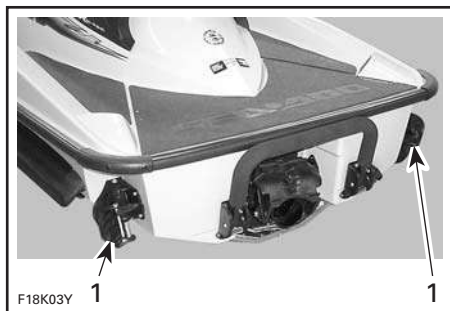

TYPICAL

1. Side vanes turn following steering movement

Models with Sliding Side Vanes (O.P.A.S. System)

When engine is running at approximately 75% or more RPM, the side vanes are automatically raised to upper position since they are not required at that vehicle speed range.

Between 30% and 75% engine RPM, side vanes are gradually raised from lower position to upper position.

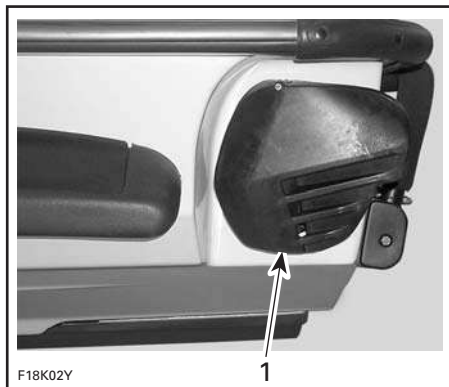

1. Side vane in upper position

When throttle is released and engine RPM drops, the side vanes are automatically lowered thus assisting steering control.

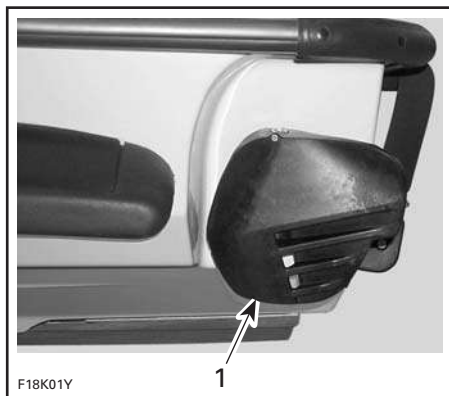

1. Side vane in lower position

All Models

Boarding the Watercraft

General

As with any watercraft, boarding should be done carefully and engine should not be running.

WARNING

Engine should be OFF when boarding the watercraft or when using boarding step. Keep limbs away from jet or intake grate. Stay on center of the step. Only one person at a time on the step. Never use the step for pulling, towing, diving or jumping, boarding a watercraft that is out of water or any other purpose other than a boarding step.

Boarding is facilitated by using a step.

WARNING

Inexperienced riders should practice how to get aboard (all methods explained here) close to shore first before venturing into deep water.

WARNING

Never use jet pump components or side vanes as a supporting point to board the watercraft.

Boarding from a Dock or in Shallow Water

When boarding from a dock, slowly place one foot on the watercraft footboard nearest the dock and, at the same time, transfer the body weight to the other side in order to balance the watercraft while holding the handlebar. Then, bring the other foot over the seat and put it on the other footboard. Push the watercraft away from the dock.



In shallow water, board the watercraft either from the side or the rear.

Ensure there is at least 90 cm (3 ft) of water underneath the lowest rear portion of the hull.

Take into account that the hull will lower in water when all passengers are aboard. Be certain to maintain the specified depth so sand, pebbles and rocks will not be drawn up in the jet pump.

CAUTION: Starting the engine or riding the watercraft in shallower water might damage the impeller or other jet pump components.

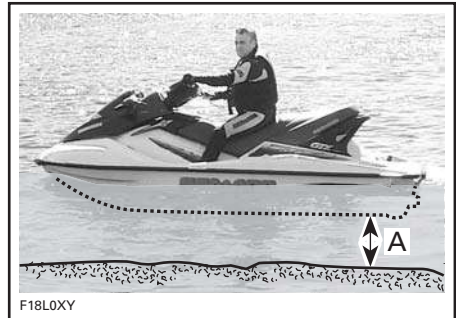

A. Maintain at least 90 cm (3 ft) underneath the lowest rear portion of the hull when all passengers are aboard

Boarding in Deep Water

Operator Alone

Swim to the rear of the watercraft.

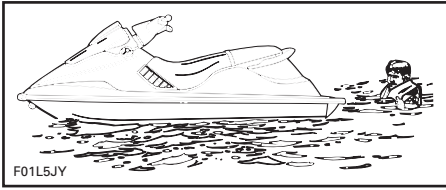

Grab the grab handle and pull yourself upward until your knee can reach the boarding platform then grip the seat strap.

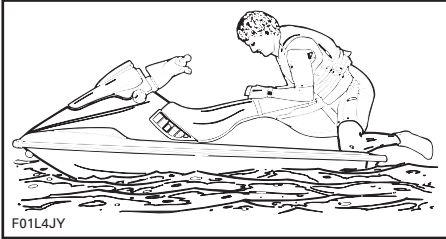

Bring your feet on the footboard while maintaining balance.

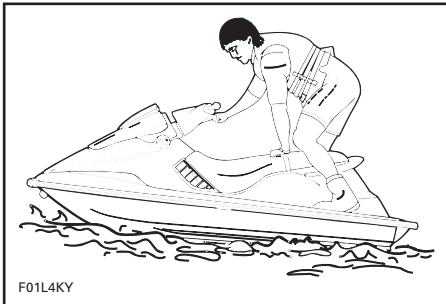

Sit astride the seat.

Operator with a Passenger

The operator climbs on the watercraft the same way as explained previously.

In choppy water, the passenger, while in the water, may hold the watercraft to help the operator in climbing aboard.

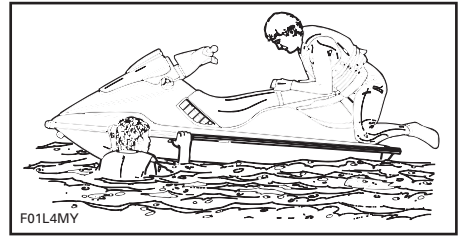

The passenger then climbs on the watercraft while the operator maintains balance by sitting as close as possible to the console.

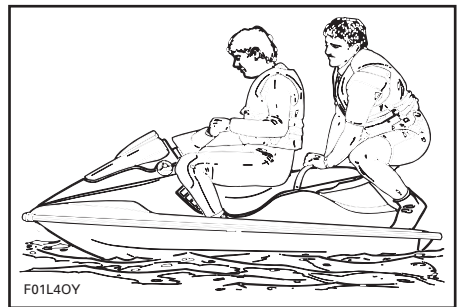
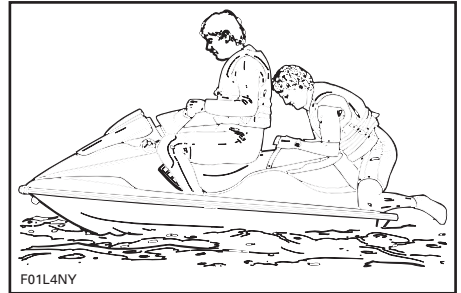

Starting

Preparation

Before unloading the watercraft from the trailer, it can be started for about 10 seconds to verify proper operation.

WARNING

Certain components in the engine compartment may be very hot. Direct contact may result in skin burn. Do not touch electrical parts or jet pump area when engine is running.

Attach the safety lanyard to your PFD and snap the cap to its post before starting the engine.

NOTE: If you hear anything else than 2 short beeps from DESS system, it indicates a particular condition that should be corrected. Refer to the *TROUBLESHOOTING* section for the meaning of the coded signal.

WARNING

Before starting the engine, the operator and passengers should always be properly seated.

Position shift lever to neutral.

Firmly grip handlebar with your left hand and place both feet on the footboards.

CAUTION: Ensure there is at least 90 cm (3 ft) of water underneath the lowest rear portion of the hull when all passengers are aboard prior to starting the engine. Otherwise damage to the impeller or other jet pump components might occur. Do not accelerate abruptly.

To start engine, depress and hold the engine start/stop button. Follow procedure below for engine starting.

If engine fails to start after 10 seconds, wait a few seconds then repeat procedure.

CAUTION: Do not hold start/stop button more than 30 seconds to avoid starter overheating. A rest period should be observed between the cranking cycles to let starter cool down. Pay attention not to discharge battery.

Release engine start/stop button immediately after engine is started.

Cold and Warm Engine

Do not depress the throttle lever to start either a cold or warm engine.

Riding

Slowly accelerate to reach deeper water. Do not apply full throttle until the engine is warm.



CAUTION: Avoid watercraft operation in weeded areas. If unavoidable, vary watercraft speed.

Operation with Wakeboard Rack

WARNING

With wakeboard and/or rack installed, operate with extra caution:

- NEVER perform aggressive maneuvers including spin-out.
- NEVER jump waves
- Use common sense and limit speed.

Otherwise, wakeboard could detach or occupants could fall off and get injured against the wakeboard or rack.

Rough Water or Poor Visibility Operation

Avoid operation in these conditions. If you must do so, proceed with caution and prudence using minimum speed.

Crossing Waves

Reduce speed.

Always be prepared to steer and balance as necessary.

When crossing wakes, always keep a safe distance from watercraft ahead.

WARNING

When crossing wakes, slow down. Operator and passenger(s) can brace themselves by posting. Do not jump waves or wakes.

Stopping/Docking

The watercraft is slowed by water drag. The stopping distance will vary depending on the watercraft size, weight, speed, water surface condition, presence and direction of wind and current.



The operator should become familiarized with the stopping distance under different conditions.

Release the throttle at a sufficient distance before the expected landing area.

Reduce speed to idle.

Shift to neutral, reverse or forward, as required.

WARNING

Directional control is reduced when the throttle is released and/or when engine is off.

Beaching

CAUTION: It is not recommended to run the watercraft to the beach.

Come slowly to the beach and shut off the engine using the safety lanyard before water depth is less than 90 cm (3 ft) under the lowest rear portion of the hull, then pull the watercraft to the beach.

CAUTION: Riding the watercraft in shallower water might damage the impeller or other jet pump components.



CAUTION: Pay attention, when leaving the watercraft on the beach, so that the side vanes do not rub or hit the ground due to the rocking movement. It might eventually damage components of the O.P.A.S. system.

Shutting Off the Engine

To keep watercraft directional control, the engine should be running until the watercraft is at idle.

To stop engine depress the start/stop button. When stopped, disconnect safety lanyard from the post. It is suggested to release throttle lever first.

To shut off the engine, press the engine start/stop button. Remove safety lanyard from watercraft.

WARNING

Should the engine be shut off, watercraft directional control is reduced. Never leave the safety lanyard on its post when watercraft is not in operation in order to prevent accidental engine starting or to avoid unauthorized use by children or others or theft.

POST-OPERATION CARE

WARNING

Allow engine to cool before performing any maintenance.

General Care

Remove the watercraft from the water every day to prevent marine organisms growth.

Should any water be present in the hull, unscrew the drain plugs and tilt the watercraft to the rear in order to allow water to flow out.

Wipe up any remaining fluid in the engine compartment (bilge, engine, battery, etc.) with clean dry rags (this is particularly important in salt water use).

Additional Care for Foul Water or Salt Water

When the watercraft is operated in foul water and particularly in salt water, additional care should be taken to protect the watercraft and its components.

It is a good practice to lubricate throttle body after every 10 hours of use, refer to *MAINTENANCE* section for procedure.

Rinse watercraft bilge area with fresh water.

Never use a high pressure washer to clean the bilge. **USE LOW PRESSURE ONLY** (like a garden hose).

High pressure can cause electrical or mechanical damages.

CAUTION: Failure to perform proper care such as: watercraft rinsing, exhaust cooling system flushing and anticorrosion treatment, when watercraft is used in salt water, will result in damage to the watercraft and its components. Never leave the watercraft stored in direct sunlight.

Exhaust Cooling System Flushing

General

Flushing the exhaust cooling system with fresh water is essential to neutralize corroding effects of salt or other chemical products present in water. It will help to remove sand, salt, shells or other particles in water jackets and/or hoses.

Flushing should be performed when the watercraft is not expected to be used further the same day or when the watercraft is stored for any extended time.

WARNING

Perform this operation in a well ventilated area.

Proceed as follows:

Clean jet pump by spraying water in its inlet and outlet and then apply a coating of XP-S LUBE or equivalent.

WARNING

When operating the engine while the watercraft is out of the water, the heat exchanger in the ride plate may become very hot. Avoid any contact with ride plate as burns may occur.

Models Without a Flushing Connector in Engine Compartment

Connect a garden hose to connector located at the rear of watercraft on jet pump support. Do not open water tap yet.

NOTE: An optional quick connect adapter can be used (P/N 295 500 473). No hose pincher is required to flush engine.

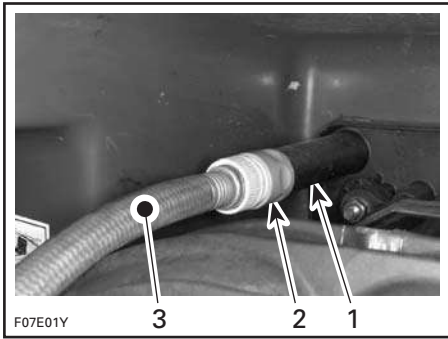

TYPICAL

1. Hose adapter
2. Quick connect adapter (optional, not mandatory)
3. Garden hose

Models with a Flushing Connector in Engine Compartment

This flushing connector allows flushing while watercraft is on a lift or if you prefer to flush from this location. Either flushing connector can be used to flush the exhaust cooling system. The one at the jet pump support (see above) or the one in the engine compartment (see below).

Remove seat to gain access.

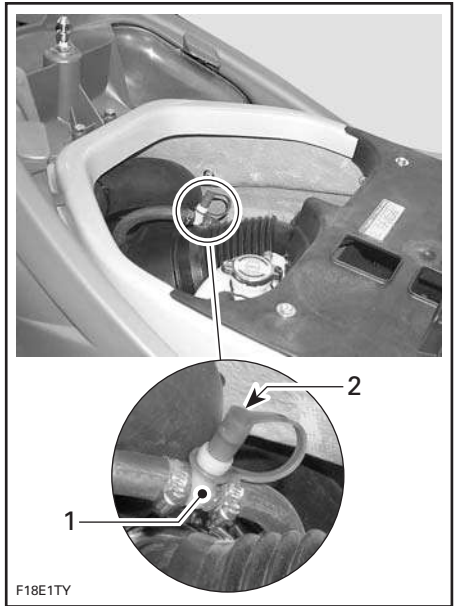

1. Flushing connector
2. Dust cap

Remove dust cap from flushing connector and attach coupler hose (supplied in rear storage compartment). Make sure coupler hose is properly locked to flushing connector.

Install a hose pincher (supplied inside tool kit in rear storage compartment) on water outlet hose.

NOTE: This prevents water from directly exiting exhaust cooling system.

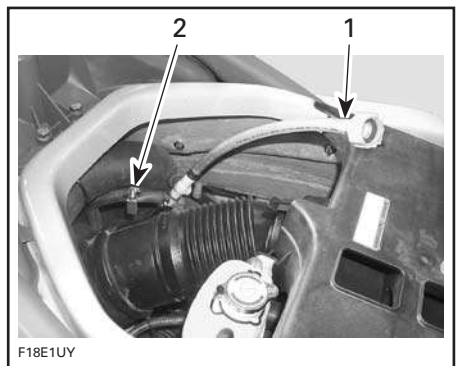

1. Coupler hose
2. Hose pincher

Attach other end of coupler hose to a garden hose. Do not open water tap yet.

Flushing

All Models

To flush the exhaust cooling system, start the engine then immediately open the water tap.

WARNING

Certain components in the engine compartment may be very hot. Direct contact may result in skin burn. Do not touch any electrical parts or jet pump area when engine is running.

CAUTION: Never flush a hot engine. Always start the engine before opening the water tap. Open water tap immediately after engine is started to prevent overheating.

Run the engine about 20 seconds at a fast idle between 4000 - 5000 RPM.

CAUTION: Never run engine without supplying water to the exhaust cooling system when watercraft is out of water.

Ensure water flows out of jet pump while flushing. Otherwise, refer to an authorized Sea-Doo dealer for servicing.

CAUTION: Never run engine longer than 5 minutes. Drive line seal has no cooling when watercraft is out of water.

Close the water tap, then stop the engine.

CAUTION: Always close the water tap before stopping the engine.

Models without a Flushing Connector in Engine Compartment

CAUTION: Remove quick connect adapter after flushing operation (if used).

Models with a Flushing Connector in Engine Compartment

Unlock and remove coupler hose. Reinstall dust cap over flushing connector.

Remove hose pincher from water outlet hose.

CAUTION: Serious engine damage can occur if hose pincher is not removed.

Anticorrosion Treatment

To prevent corrosion, spray a corrosion inhibitor (salt water resistant) such as XP-S LUBE or equivalent over metallic components in engine compartment.

Apply dielectric grease (salt water resistant) on battery posts and cable connectors.

CAUTION: Never leave rags or tools in the engine compartment or in the bilge.

SPECIAL PROCEDURES

Monitoring System

To assist you when using the watercraft, a system monitors the electronic components of the EMS (engine management system) and other components of the electrical system. When a fault occurs, it sends visual messages through the information center and/or audible signals through a beeper to inform you of a particular condition. Refer to the *INFORMATION CENTER GAUGE* for the displayed messages and the *TROUBLESHOOTING* section for the beeper coded signals chart.

When minor faults occur, the fault and message/beeper will disappear automatically if the condition does not exist anymore.

Releasing throttle and letting the engine returning at idle speed may allow normal operation to come back. If it does not work, try removing and reinstalling the safety lanyard on its post.

The electronic system will react differently depending on the fault type. In severe failure, the engine might not be allowed to be started. In other cases, the engine will operate in limp home mode. See below.

When a fault occurs, see an authorized Sea-Doo dealer as soon as possible for inspection.

Limp Home Modes

Besides the signals as seen above, the EMS may automatically set default parameters to ensure the adequate operation of the watercraft if an electronic component is not operating properly.

Depending on the severity of the malfunction, the watercraft speed may be reduced and not allowed to reach its top speed as usual.

In this mode, it may be necessary to depress the throttle quite slowly to allow engine RPM to increase and operate the watercraft to go back home.

These performance-reduced modes allow the rider to go back home which would not be possible without this advanced system.

Engine Overheating

CAUTION: If the monitoring beeper continuously sounds, stop engine as soon as possible.

Check coolant level. Refer to *LIQUIDS*. If engine still overheats, continue the following procedure.

Perform *JET PUMP WATER INTAKE AND IMPELLER CLEANING* procedure described in this section.

When back to shore, flush exhaust cooling system, refer to *POST-OPERATION CARE*.

If engine still overheats, refer to an authorized Sea-Doo dealer for servicing.

Engine Low Oil Pressure

CAUTION: If the monitoring beeper continuously sounds, stop engine as soon as possible.

Turn off engine as soon as possible. Check oil level and refill.

Restart the engine. If this does not correct the situation, do not run the engine further. Refer to an authorized Sea-Doo dealer for servicing.

CAUTION: Running engine with low oil pressure may severely damage the engine.

Jet Pump Water Intake and Impeller Cleaning

WARNING

Keep away from intake grate while engine is on. Items such as long hair, loose clothing or personal flotation device straps can become entangled in moving parts resulting in severe injury or drowning.

Weeds, shells or debris can get caught on the intake grate, drive shaft and/or impeller. A clogged water intake may cause troubles such as:

- Cavitation: Engine speed is high but watercraft moves slowly due to reduced jet thrust, jet pump components may be damaged.
- Overheating: Since the jet pump operation controls the flow of water to cool the exhaust system, a clogged intake will cause the engine to overheat and damage engine internal components.

A weed clogged area can be cleaned as follows:

In-Water Cleaning

Rock the watercraft several times while repeatedly pressing engine start/stop button for short period without starting engine. Most of the time, this will remove the blockage. Start engine and make sure watercraft operates properly.

If system is still blocked, move the watercraft out of the water and remove blockage manually.

If the aforementioned method does not work, the following can be performed:

- With engine running and before applying throttle, put shift lever in reverse position and vary throttle quickly several times.
- Repeat procedure if necessary.

On-Beach Water Cleaning

WARNING

Always remove safety lanyard cap from its post to prevent accidental engine starting before cleaning the jet pump area.

Place a cardboard or a carpet beside the watercraft to prevent scratching when turning the watercraft for cleaning.

Rotate the watercraft to any side for cleaning.

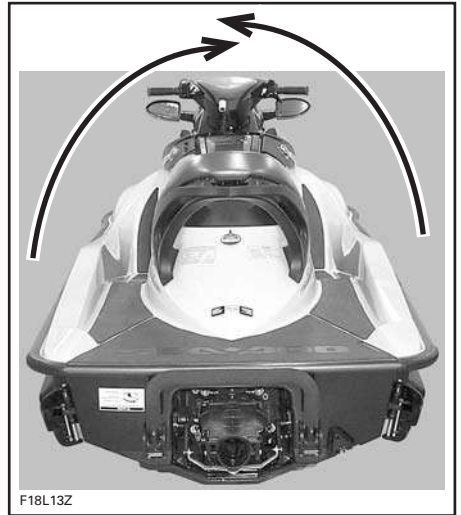

TYPICAL

Clean the water intake area. If the system is still clogged, refer to an authorized Sea-Doo dealer for servicing.

CAUTION: Inspect water intake grate for damage. Refer to an authorized Sea-Doo dealer for repair as necessary.

Capsized Watercraft

The watercraft is designed so that it should not turn over easily. Also two sponsons mounted on the side of the hull assist watercraft stability. If it turns over, it will remain capsized.

WARNING

When watercraft is capsized, do not attempt to restart the engine. Operator and passengers should always wear approved personal flotation devices.

To return the watercraft upright, ensure the engine is off and the safety lanyard is NOT on its post then grab the inlet grate, step on bumper rail and use your weight to rotate the watercraft in any direction.

The 4-TEC engine features a tip-over protection system (T.O.P.S™). When watercraft tips over, engine is automatically stopped, then a valve is closed to prevent engine oil to flow back in intake system.

When watercraft is returned to its normal operating position, engine can then be started normally.

CAUTION: If watercraft has been capsized for more than 5 minutes, do not attempt to crank engine to avoid water ingestion that would damage the engine. See an authorized Sea-Doo dealer as soon as possible.

CAUTION: If engine does not crank, do not attempt to start engine anymore. Otherwise engine could be damaged. See an authorized Sea-Doo dealer as soon as possible.

As soon as possible, check for presence of water in the bilge. Drain as necessary when back to the shore.

Submerged Watercraft

To limit damages to the engine, perform the following procedure as soon as possible.

Drain bilge.

If it was submerged in salt water, spray bilge and all components with fresh water using a garden hose to stop the salt corroding effect.

CAUTION: Never try to crank or start the engine. Water trapped in intake manifold would flow towards the engine and may cause severe damage to the engine.

Bring the watercraft to be serviced by an authorized Sea-Doo dealer as soon as possible.

CAUTION: The longer the delay before you have the engine serviced, the greater the damage to the engine will be.

Water-Flooded Engine

CAUTION: Never try to crank or start the engine. Water trapped in intake manifold would flow towards the engine and may cause severe damage to the engine.

Bring the watercraft to be serviced by an authorized Sea-Doo dealer as soon as possible.

CAUTION: The longer the delay before you have the engine serviced, the greater the damage to the engine will be. Failure to have the engine properly serviced may cause severe engine damage.

Fuel-Flooded Engine

When the engine does not start after several attempts, the engine may be fuel-flooded. Proceed as follows.

To prevent fuel to be injected and also to cut the ignition at the engine cranking, proceed as follows.

While engine is stopped, fully depress throttle lever and HOLD for cranking.

Crank engine several times.

If it does not work:

Pull engine cover upward to remove it.

Disconnect ignition coil connectors.

WARNING

When disconnecting coil from spark plug, always disconnect coil from main harness first. Never check for engine ignition spark from an open coil and/or spark plug in the engine compartment as spark may cause fuel vapor to ignite.

Remove ignition coils.

CAUTION: Ensure there is no dirt in coil holes prior to removing the spark plugs. Otherwise, dirt would fall into cylinder and will damage the internal components.

Remove spark plugs.

NOTE: After untightening the spark plugs, a coil may be used to pull the spark plugs out. Simply bring the coil down to spark plug and "hook" it to then extract spark plug.

Install new spark plugs if available or dry spark plugs using a rag.

Cover spark plug holes with a rag.

Crank engine several times while keeping throttle fully depressed.

Reinstall spark plugs and ignition coils. Install clean dry spark plugs if possible. Reconnect ignition coil connector.

NOTE: Prior to inserting the ignition coil to its location, apply some Molykote 111 grease (P/N 413 707 000) around the seal area that touches the spark plug hole. After installation, ensure the seal seats properly with the engine top surface.

To reinstall engine cover, push it downward until it snaps.

Start engine as explained above. If engine continues to flood, see an authorized Sea-Doo dealer.

CAUTION: Never run engine without supplying water to the exhaust cooling system when watercraft is out of water.

Towing the Watercraft in Water

Special precautions should be taken when towing a Sea-Doo watercraft in water.

Maximum recommended towing speed is 24 km/h (15 MPH).

When towing your watercraft in water, pinch the water supply hose from the impeller housing to the exhaust manifold with a large hose pincher (P/N 529 032 500).

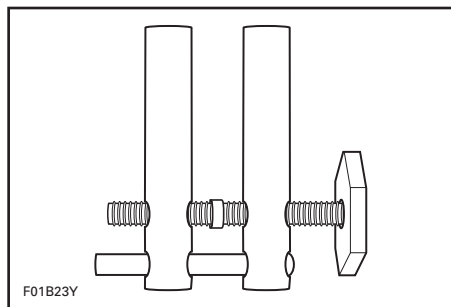

This will prevent the exhaust cooling system from filling which may lead to water being injected into and filling the engine. Without the engine running there isn't any exhaust pressure to carry the water out the exhaust outlet.

CAUTION: Failure to do this may result in damage to the engine. If you must tow a stranded watercraft in water and do not have a hose pincher, be sure to stay well below the maximum towing speed of 24 km/h (15 MPH).

To ease access to the hose, the vent tube can be temporarily removed.

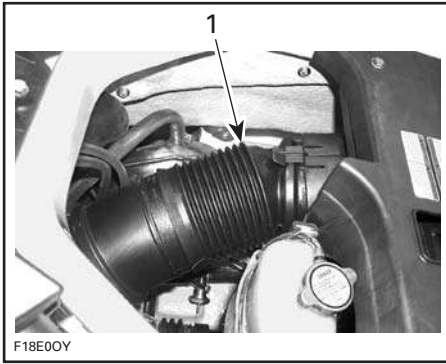

1. Vent tube

Lift lock tab and holding the tab, pull the tube to release it.

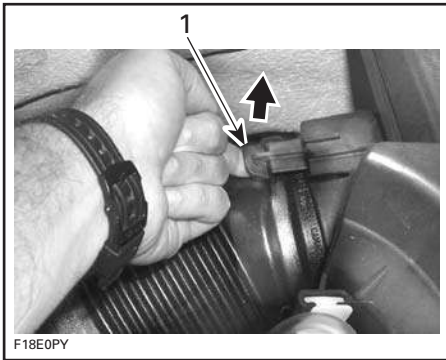

1. Lift lock tab

Then proceed with the tab under the tube. Refer to the following illustration to see it.

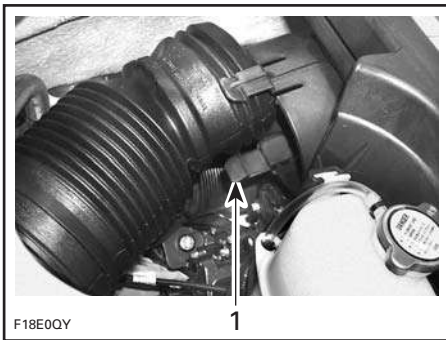

1. Other lock tab under tube

Snugly install the hose pincher on the water supply hose as shown.

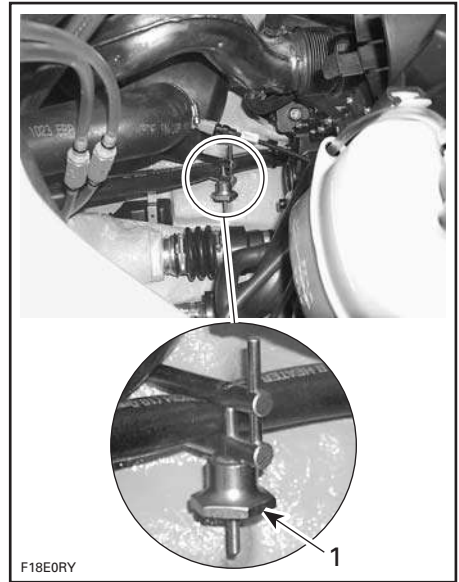

TYPICAL
1. Hose pincher

NOTE: A red tape on the water supply hose indicates which hose to pinch.

CAUTION: When finished towing the watercraft, hose pincher must be removed before operating it. Failure to do so will result in damage to the engine.

After removal of hose pincher, properly reinstall and lock vent tube. When pushing tube in place, you should hear a click that validates it is locked.

Low-Charge Battery Condition

See an authorized Sea-Doo dealer to have it charged or replaced.

⚠ WARNING

Do not charge or boost the battery while installed on the watercraft. Electrolyte is poisonous and dangerous. Avoid contact with eyes, skin and clothing.

MAINTENANCE INFORMATION

Maintenance, replacement, or repair of the emission control devices and systems may be performed by any marine SI (spark ignition) engine repair establishments or individual.

Engine Emissions Information

Manufacturer's Responsibility

Beginning with 1999 model year engines, PWC manufacturers of marine engines must determine the exhaust emission levels for each engine horsepower family and certify these engines with the United States of America Environmental Protection Agency (EPA). An emissions control information label, showing emission levels and engine specifications, must be placed on each vehicle at the time of manufacture.

Dealer's Responsibility

When performing service on all 1999 and more recent Sea-Doo watercraft that carry an emissions control information label, adjustments must be kept within published factory specifications.

Replacement or repair of any emission related component must be executed in a manner that maintains emission levels within the prescribed certification standards.

Dealers are not to modify the engine in any manner that would alter the horsepower or allow emission levels to exceed their predetermined factory specifications.

Exceptions include manufacturer's prescribed changes, such as altitude adjustments for example.

Owner Responsibility

The owner/operator is required to have engine maintenance performed to maintain emission levels within prescribed certification standards.

The owner/operator is not to, and should not allow anyone to modify the engine in any manner that would alter the horsepower or allow emissions levels to exceed their predetermined factory specifications.

EPA Emission Regulations

All new 1999 and more recent Sea-Doo watercraft manufactured by BRP are certified to the EPA as conforming to the requirements of the regulations for the control of air pollution from new watercraft engines. This certification is contingent on certain adjustments being set to factory standards. For this reason, the factory procedure for servicing the product must be strictly followed and, whenever practicable, returned to the original intent of the design.

The responsibilities listed above are general and in no way a complete listing of the rules and regulations pertaining to the EPA requirements on exhaust emissions for marine products. For more detailed information on this subject, you may contact the following locations:

For all courier services:

U.S. Environmental Protection Agency
Office of Transportation and Air Quality
1310 L Street NW
Washington, DC 20005

Regular US Postal Mail:

1200 Pennsylvania Ave. NW
Mail code 6403J
Washington, DC 20460

EPA INTERNET WEB SITE:

<http://www.epa.gov/otaq>

EPA E-MAIL:

otaqpublicweb@epa.gov

General

Only perform servicing procedures which are detailed in this safety section. Further assistance or information can be obtained from your authorized Sea-Doo dealer. In many instances proper tools and training is required for certain servicing or repair procedures.

Maintain the watercraft and equipment in top condition at all times. Adhere to the prescribed maintenance schedules. An annual inspection of the watercraft is always a good recommendation that should be followed.

Always use spark plug cable grounding device when removing spark plugs.

The bilge should be kept clean of oil, water or other foreign materials.

Do not attempt to lift the watercraft without special equipment and training.

The engine and the corresponding components identified in this guide should not be utilized on product(s) other than for which they were designed. Maintenance procedures and specified tightening torque should be strictly adhered to. Never attempt repairs unless the appropriate tools are available. These watercrafts are designed with parts dimensioned in both the metric and the imperial systems. When replacing fasteners, make sure to use only those recommended by BRP. If required, contact your authorized Sea-Doo dealer for further servicing information.

MAINTENANCE CHART

Periodic Inspection

Routine maintenance is necessary for all mechanized products. A periodic inspection contributes to the product's life span.

The following maintenance chart gives guidelines for regular watercraft servicing scheduled to be performed by you and/or by an authorized Sea-Doo dealer. The schedule should be adjusted according to operating conditions and use.

IMPORTANT: Schedule for watercraft rental operations or higher number of hour use, will require greater frequency of inspection and maintenance.

The maintenance is very important, if you are not familiar with safe service practices and adjustment procedures, see your authorized Sea-Doo dealer.

NOTE: Some items are included in the *PRE-OPERATION CHECKS* and not necessarily repeated in this chart.

PERIODIC MAINTENANCE CHART

A: ADJUST C: CLEAN I: INSPECT L: LUBRICATE R: REPLACE T: PROCEED WITH TASK	FIRST 10 HOURS						
	25 HOURS OR 3 MONTHS						
	50 HOURS OR 6 MONTHS						
	100 HOURS OR 1 YEAR						
	200 HOURS OR 2 YEAR						
	TO BE PERFORMED BY						
PART/TASK							LEGEND
GENERAL							
Lubrication/corrosion protection			T			Operator	
ENGINE							
Engine oil and filter including cover's O-rings	R			R ⁽⁷⁾		Dealer	(5) Emission-related component. (7) Perform at storage period or after 100 hours of use whichever comes first. (10) Perform every 100 hours for NA and supercharged engines. Perform every 200 hours for supercharged intercooled engines.
Support and rubber mount	I			I		Dealer	
Seals and fasteners	I			I		Dealer	
Exhaust system fasteners ⁽⁵⁾	I			I		Dealer	
Spark plug ⁽⁵⁾	I			I	R	Dealer	
Supercharger slipping moment (if so equipped)					I	Dealer	
COOLING SYSTEM							
Flushing (exhaust system)		T ⁽³⁾		T ⁽⁷⁾		Operator	(3) Daily flushing in salt water or foul water use. (7) Perform at storage period or after 100 hours of use whichever comes first.
Hose and fasteners	I					Dealer	
Coolant	I				R	Dealer	
FUEL SYSTEM							
Throttle cable	I			I ⁽⁷⁾		Dealer	(1) In salt water use, see <i>POST-OPERATION CARE</i> section. (5) Emission-related component. (7) Perform at storage period or after 100 hours of use whichever comes first.
Fuel injection system sensors	I			I		Dealer	
Fault code reading ⁽⁵⁾	I			I		Dealer	
Fuel lines, connections, pressure relief valve and fuel system pressurization ⁽⁵⁾	I			I		Dealer	
Throttle body	I			L ⁽¹⁾		Dealer/Operator	
Throttle position sensor ⁽⁵⁾	I			I		Dealer	
Air intake silencer fit/tightness	I			I		Dealer	
Fuel tank straps	I			I		Dealer	

PERIODIC MAINTENANCE CHART

A: ADJUST C: CLEAN I: INSPECT L: LUBRICATE R: REPLACE T: PROCEED WITH TASK	FIRST 10 HOURS					
	25 HOURS OR 3 MONTHS					
	50 HOURS OR 6 MONTHS					
	100 HOURS OR 1 YEAR					
	200 HOURS OR 2 YEAR					
	TO BE PERFORMED BY					
PART/TASK						LEGEND

ELECTRICAL SYSTEM

Electrical connections and fastening (ignition system, starting system, fuel injectors etc.)	I				I		Dealer	(10) In salt water use.
MPEM and ECM connectors					I ⁽¹⁰⁾		Dealer	
Digitally Encoded Security System and safety lanyard/post	I				I		Dealer	
Monitoring beeper	I				I		Dealer	
Battery and fasteners	I				I		Dealer	

STEERING SYSTEM

Steering cable	I				I		Dealer	
Steering nozzle bushings	I				I		Dealer	

O.P.A.S. SYSTEM

O.P.A.S. system	I				I		Dealer	(8) Every 25 hours when riding in weed areas.
O.P.A.S. filter (if applicable)		I ⁽⁸⁾					Operator	

PROPULSION SYSTEM

Drive shaft corrosion protection					L ⁽⁹⁾		Dealer	(2) These items have to be initially checked after 25 hours. Thereafter, servicing to be made as specified in this chart. (6) Replace after the vehicle completed 100 hours of use or 2 years. (9) Perform at storage period or after 100 hours of use whichever comes first.
Drive line inspection: cables connections, impeller booth, drive shaft splines, carbon ring and rubber booth	I				I		Dealer	
Drive shaft impeller splines					L		Dealer	
Sacrificial anode (if so equipped)					I ⁽⁹⁾		Dealer	
Reverse system/cable	I				I		Dealer	
VTS (Variable Trim System), (if so equipped)	I				I		Dealer	
Impeller and impeller/wear ring clearance	I				I		Dealer	
Ride plate and water intake grate	I				I		Operator	
Drive shaft/hull sealing system	I				I		Dealer	

PERIODIC MAINTENANCE CHART

A: ADJUST
 C: CLEAN
 I: INSPECT
 L: LUBRICATE
 R: REPLACE
 T: PROCEED WITH TASK

FIRST 10 HOURS

25 HOURS OR 3 MONTHS

50 HOURS OR 6 MONTHS

100 HOURS OR 1 YEAR

200 HOURS OR 2 YEAR

TO BE PERFORMED BY

PART/TASK

LEGEND

HULL AND BODY

Drain plugs (inside bilge), check for obstructions	I				I		Operator
Hull	I				I		Operator
Ski/wakeboard post and fasteners	I						Operator

MAINTENANCE

WARNING

Only perform procedures as detailed in this guide. It is recommended that the assistance of an authorized Sea-Doo dealer be periodically obtained on other components/systems not covered in this guide. Unless otherwise specified, engine must not be running and the safety lanyard must be removed from its post for all maintenance procedures. Never use jet pump components or side vanes to lift the watercraft. Certain components in the engine compartment may be very hot. Direct contact may result in skin burn. When operating the engine while the watercraft is out of the water, the heat exchanger in the ride plate may become very hot. Avoid any contact with ride plate as burns may occur.

Lubrication

Anticorrosion Protection

Throttle Cable

Lubricate the throttle cable with XP-S LUBE or equivalent.

Throttle Body

Lubricate throttle body with XP-S LUBE or an equivalent.

Models Equipped with Lubrication Fitting

Use fitting for that purpose provided in the engine compartment.

Make sure to spray lubricant at least 3 to 5 seconds for proper lubrication.



GTI MODELS — TYPICAL
1. Fitting



OTHER MODELS — ENGINE COVER
1. Fitting

Models Without Lubrication Fitting

Remove the air intake hose from throttle body.

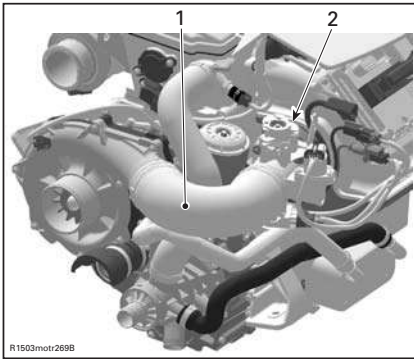

TYPICAL

1. Air intake hose
2. Throttle body

Open the throttle body valve by pressing slightly the throttle lever.

Spray XP-S LUBE lubricant through the throttle body bore to lubricate valve mechanism.

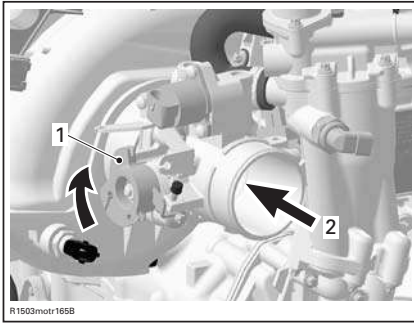

TYPICAL

1. Open throttle body valve
2. Lubricate valve mechanism

Reinstall air intake hose.

Electrical Connections

As necessary, apply anticorrosion product such as dielectric grease on battery posts and all exposed cable connectors.

CAUTION: Do not lubricate connectors of the Multi-Purpose Electronic Module (MPEM) and the engine Electronic Control Module (ECM).

Additional Lubrication

XP-S LUBE or equivalent will help prevent corrosion of metallic parts and maintain proper operation of moving mechanisms.

⚠ WARNING

Do not lubricate the safety lanyard post.

Ski/Wakeboard Post (if so equipped)

Lubricate ski/wakeboard post through all its length. Pull out then push in several times to distribute the lubricant.

Reverse Gate

Lubricate pivoting points and mechanism.

Throttle Cable Inspection

Throttle Cable

Depress and release the throttle lever. It should operate smoothly and return to its initial position without any hesitation. There must be a small amount of free-play when throttle lever is released. Refer to an authorized Sea-Doo dealer if necessary.

CAUTION: Never attempt to adjust the idle speed through the throttle body tamper proof screw. If so, it would impair the idle speed stability. Besides, no adjustment could be performed by the dealer nor the factory to correct the idle speed. The throttle body would need to be replaced at the customer's expense. Also take into account that might change the engine emission level and the engine might not meet the EPA/CARB requirements.

⚠ WARNING

Do not alter or tamper with throttle cable adjustment or routing.

WARNING

If throttle lever does not automatically return, do not operate watercraft and see your authorized Sea-Doo dealer.

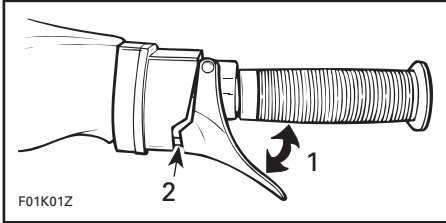

1. Should move freely
2. Slight free-play must be present here

Engine Oil Change and Oil Filter Replacement

The oil change and filter replacement should be performed by an authorized Sea-Doo dealer.

Valve Adjustment

There is no valve adjustment to be performed on this engine.

Coolant Replacement

The coolant replacement should be performed by an authorized Sea-Doo dealer.

Fuel Injection System

The fuel injection system inspection should be performed by an authorized Sea-Doo dealer. Fuel system pressurization should be conducted at the same time.

Steering Alignment

When the handlebar is directed in straight ahead position, the jet pump nozzle should be in the same direction allowing the watercraft to run in a straight line. The rear edge of side vanes should be pointing out side by approximately 20° when the handlebar is pointing straight ahead.

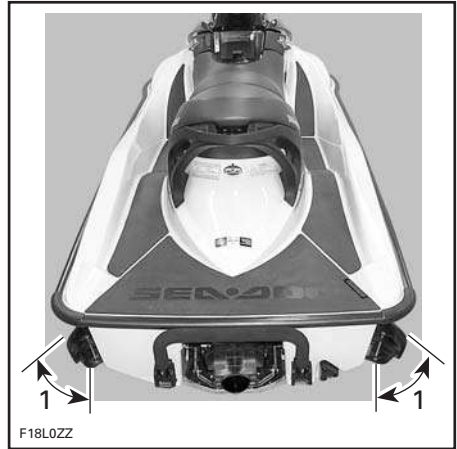

1. Approximately 20° when handlebar is pointing straight ahead

Refer to an authorized Sea-Doo dealer if an adjustment is necessary.

WARNING

Ensure the handlebar and jet pump nozzle operate freely from side to side and are not stressing the steering cable or brackets. Never turn handlebar while someone is nearby rear of watercraft. Keep away from steering moving parts (nozzle, side vanes, linkage etc.).

VTS Adjustment (if so equipped)

Push on arrow pointing upward on VTS button until the VTS stops. The nozzle should be up without interfering with the venturi.

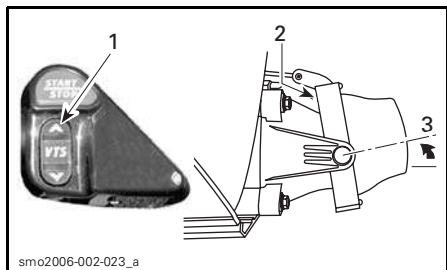

TYPICAL

1. Push on arrow pointing upward on VTS button
2. No interference
3. Nozzle up

Push on arrow pointing downward on VTS button until VTS stops. The nozzle must be down and it must not interfere with the venturi.

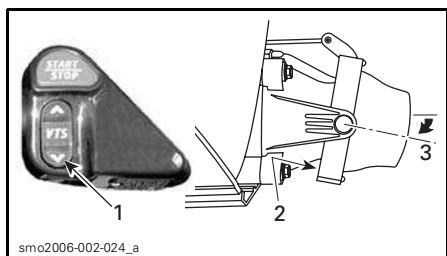

TYPICAL

1. Push on arrow pointing downward on VTS button
2. No interference
3. Nozzle down

If VTS needs to be readjusted, refer to an authorized Sea-Doo dealer.

CAUTION: Trim ring and/or nozzle should not interfere at any position.

Bilge Drain Plugs

Drain plugs use a low pressure area in the jet pump to siphon the water out of the bilge when the engine is operating. Inspect each pick-up screen for obstructions, clean as necessary.

Fuses

If an electrical problem occurs, check the fuses. If a fuse is burnt, replace by one of the same rating.

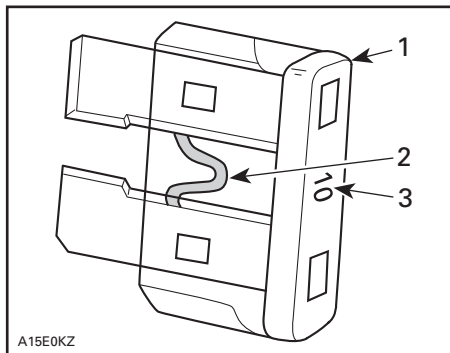

1. Fuse
2. Check if melted
3. Ampere rating

Follow procedures below.

⚠ WARNING

Do not use a higher rated fuse as this can cause severe damage. If a fuse has burnt out, source of malfunction should be determined and corrected before restarting. See an authorized Sea-Doo dealer for servicing.

All Models except RXP

Fuses can be found on the MPEM in engine compartment.

RXP Models

Fuses are located under basket in front storage compartment.

NOTE: To understand the acronyms used here, refer to *ABBREVIATIONS USED IN THIS MANUAL* section at the end of the guide.

MPEM

All Models except RXP

To access fuses on the MPEM, remove seat.

Locate MPEM beside engine.

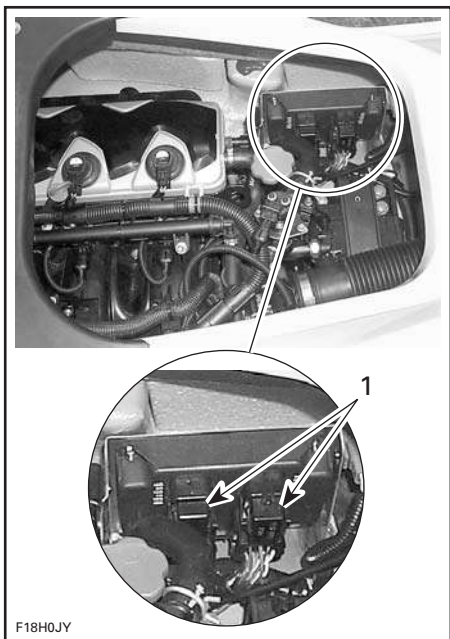

TYPICAL
1. Fuses

RXP Models

Open front storage compartment and remove basket to locate MPEM.

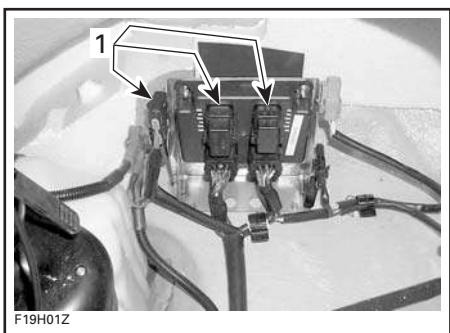

1. Fuses

All Models

Fuses rating are identified, look beside the fuse holders.

Fuse Identification

		MPEM	
Camshaft position sensor	10A		3A Bilge pump (optional), beeper, diagnostic connector
Spare fuse (accessory), Depth sounder (GTX LTD)	2A		5A Information center gauge, TOPS sensor
Cylinder 3 ignition coil and injection	10A		10A Electric starter, fuel pump
Spare fuse (permanent 12V)	1A		2A MPEM
Cylinder 2 ignition coil and injection	10A		7.5A VTS (if so equipped)
Cylinder 1 ignition coil and injection	10A		5A EMS, start/stop switch

Squeeze locking tabs together, hold and pull fuse cover from the MPEM.

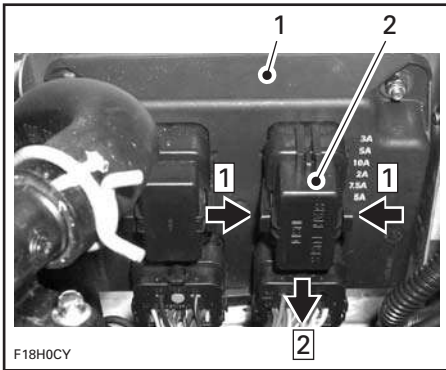

F18H0CY

TYPICAL

1. MPEM
2. Fuse cover

Use the tabs of the fuse cover to remove and reinstall fuses. Slide cover tabs along fuse top.

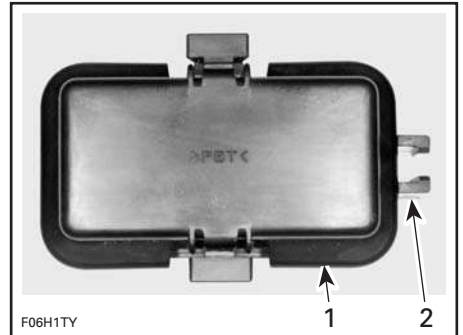

1. Fuse cover
2. Fuse tabs

One cover contains spare fuses.

To gain access to spare fuses, remove the cover identified "SPARE FUSES INSIDE". Look inside cover and pull the rubber protector with a finger. Take care not to drop the fuses.

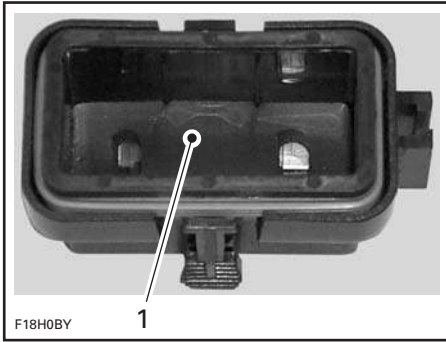

F18H0BY

1

1. Rubber protector

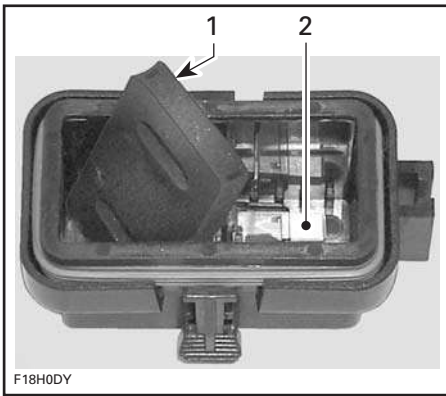

F18H0DY

1

2

1. Rubber protector
2. Spare fuses

When finished, reinstall the remaining fuse(s) and reinstall the protector over fuse(s).

CAUTION: Do not install more than 4 fuses in cover to allow proper installation of cover.

Main Fuses

They are located beside the MPEM. See below for details.

Main Fuse Beside MPEM

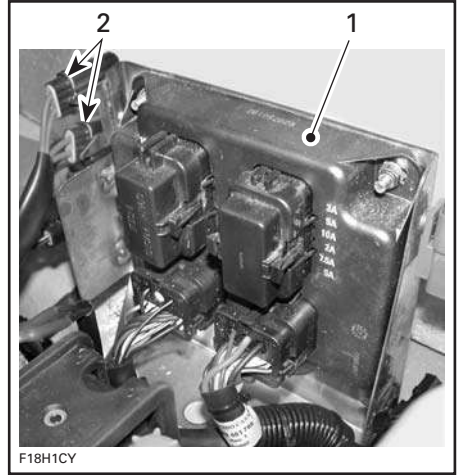

F18H1CY

TYPICAL
1. MPEM
2. Main fuse

To remove fuse cover, lift tab then pull holder out. Pull fuse out using cover on MPEM as shown above.

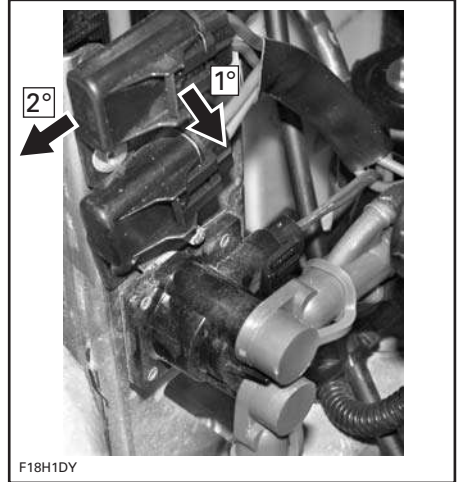

F18H1DY

TYPICAL

Reassemble removed parts.

O.P.A.S. System (if so equipped)

The O.P.A.S. system operation and condition should be checked by an authorized Sea-Doo dealer.

Drive Shaft Corrosion Protection

To give additional protection to drive shaft against possible corrosion in salt water conditions, it is recommended to bring the watercraft to an authorized Sea-Doo dealer for proper lubrication.

Ski/Wakeboard Post (if so equipped)

Check ski/wakeboard post operation. Ensure it slides up and down easily. Check locking mechanism operation. Check fasteners tightness. If something is found defective, don't use ski/wakeboard post and see an authorized Sea-Doo dealer for repair.

General Inspection and Cleaning

Inspection

Check engine compartment for any damage and for leaks of fuel, coolant or oil. Ensure all hose clamps are properly secured and no hose is cracked, kinked or presenting any other damage.

WARNING

If any gasoline leak and/or odor are present, do not start the engine. Have the watercraft serviced by an authorized Sea-Doo dealer.

Inspect muffler, battery, fuel tank and oil reservoir fastening devices. Visually check electrical connections for corrosion and tightness.

Inspect hull and jet pump water intake grate for damage. Replace or have damaged parts repaired.

WARNING

Periodically verify the seat lock pin and tighten if needed. Make sure seat securely latches.

Cleaning

The bilge should be cleaned by an authorized Sea-Doo dealer to remove any fuel/oil/electrolyte deposits and mildew.

Occasionally, wash the body with water and soap (only use mild detergent). Remove any marine organisms from engine and/or hull. Apply non-abrasive wax such as silicone wax.

CAUTION: Never clean fiberglass and plastic parts with strong detergent, degreasing agent, paint thinner, acetone, etc.

Stains may be removed from seat and fiberglass with Knight's Spray-Nine from Korkay System Ltd or the equivalent.

To clean the carpets, use 3M™ Citrus Base Cleaner (24 oz spray can) or the equivalent.

Respect the environment by ensuring fuel, oil or cleaning solutions do not drain into the waterways.

TRAILERING, STORAGE AND PRESEASON PREPARATION

Trailer

CAUTION: To avoid damaging O.P.A.S. side vanes, the maximum trailer wood bunks span including bunk width should not exceed 71 cm (28 in). Ends of both trailer wood bunks should not be more than 2.59 m (102 in) away from watercraft bow attachment point. See following illustration.

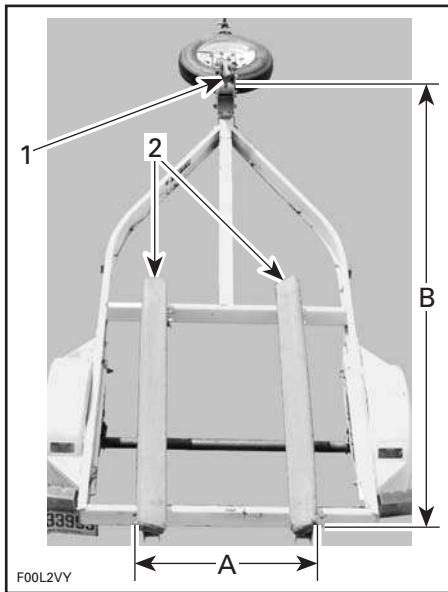

TRAILER FOR O.P.A.S.

1. Watercraft front (bow) attachment point
 2. Wood bunks
- A. 71 cm (28 in)
B. 2.59 m (102 in)

Make sure that fuel tank cap is properly installed.

⚠ WARNING

Never tip this vehicle on end for transporting. We recommend that you carry the vehicle in its normal operating position.

Check the applicable laws and regulations in your area concerning towing a trailer, especially the following rules:

- brake system
- tow vehicle weight
- mirrors.

Take the following precautions when towing the watercraft:

Tie the watercraft to both front and rear (bow/stern) eyelets so that it is firmly retained on the trailer. Use additional tie-downs if necessary.

CAUTION: Do not route ropes or tie-downs over the seat or grab handle as they could produce permanent damage. Wrap ropes or tie-downs with rags or similar protectors where they can touch the watercraft body.

Ensure all storage compartment covers and seat are properly latched.

⚠ WARNING

Make sure seat is securely latched before prior to trailering.

Models with a Wakeboard Rack

⚠ WARNING

When trailering the watercraft, NEVER leave a wakeboard installed on the rack. Otherwise, wakeboard fin(s) could cause injury to bystanders or wakeboard could fly off on the road.

⚠ WARNING

The bungee cords are under tension and could spring back and whip someone when released. Use caution.

NOTE: When trailering 2 watercraft, it may be necessary to remove the inner wakeboard rack.

All Models

A Sea-Doo cover can protect the watercraft, particularly before driving on dirt roads, to prevent dirt entry through the air intake openings.

Observe trailering safety precautions.

Launching/Loading

CAUTION: Before launching the watercraft, ensure the bilge drain plugs are fully screwed. After loading the watercraft, ensure they are removed to drain bilge.

Storage

WARNING

Because fuel and oil are flammable, have an authorized Sea-Doo dealer inspect the fuel system integrity as specified in the periodic inspection chart.

It is recommended that the watercraft be serviced by an authorized Sea-Doo dealer for storage but the following operations can be performed by you with a minimum of tools.

CAUTION: Do not run the engine during the storage period.

Body Rinsing/Repair

Wash the body with soap and water solution (only use mild detergent). Rinse thoroughly with fresh water. Remove marine organisms from the hull.

CAUTION: Never clean fiberglass and plastic parts with strong detergent, degreasing agent, paint thinner, acetone, etc.

For gelcoat repairs, refer to an authorized Sea-Doo dealer. Replace damaged labels/decals.

Fuel System

Sea-Doo fuel stabilizer (or equivalent), can be added in fuel tank to prevent fuel deterioration and fuel system gumming. Follow stabilizer manufacturer's instructions for proper use.

CAUTION: Fuel stabilizer should be added prior to engine lubrication to ensure fuel system components protection against varnish deposits.

WARNING

Always stop the engine before refueling. Fuel is flammable and explosive under certain conditions. Always work in a well ventilated area. Do not smoke or allow open flames or sparks in the vicinity. Fuel tank may be pressurized, turn cap slowly when opening. Never use an open flame to check fuel level. When fueling, keep watercraft level. Do not overfill or top off the fuel tank and leave watercraft in the sun. As temperature increases, fuel expands and might overflow. Always wipe off any fuel spillage from the watercraft. Periodically verify fuel system. Always turn the fuel tank valve (if so equipped) to OFF position when the watercraft is not in use.

Engine Oil and Filter Replacement

The oil change and filter should be performed by an authorized Sea-Doo dealer.

Exhaust Cooling System Flushing and Engine Internal Lubrication

Flushing

Connect a garden hose to cool the exhaust system as explained in FLUSHING under POST-OPERATION CARE.

Bring engine to normal operating temperature.

CAUTION: Properly follow the instructions given in the flushing procedure.

Close the water tap, then stop the engine.

Lubrication

Pull engine cover upward to remove it. Disconnect ignition coil connectors.

WARNING

When disconnecting coil from spark plug, always disconnect coil from main harness first. Never check for engine ignition spark from an open coil and/or spark plug in the engine compartment as spark may cause fuel vapor to ignite.

IMPORTANT: Never cut the locking ties of ignition coil connectors. This would allow mixing the wires between cylinders.

Remove ignition coils.

CAUTION: Ensure there is no dirt in coil holes prior to removing the spark plugs. Otherwise, dirt would fall into cylinder and will damage the internal components.

Remove spark plugs.

NOTE: After untightening the spark plugs, a coil may be used to pull the spark plugs out. Simply bring the coil down to spark plug and "hook" it to then extract spark plug.

Spray XP-S LUBE or equivalent, in spark plug holes.

To prevent fuel to be injected and also to cut the ignition at the engine cranking, proceed as follows.

While engine is stopped, fully depress throttle lever and HOLD for cranking.

Crank the engine a few turns to distribute the oil on cylinder wall.

Apply anti-seize lubricant on spark plug threads then reinstall them.

NOTE: Prior to inserting the ignition coil to its location, apply some Molykote 111 grease (P/N 413 707 000) around the seal area that touches the spark plug hole. After installation, ensure the seal seats properly with the engine top surface.

Reinstall ignition coils. Reconnect ignition coil connectors.

To reinstall engine cover, push it downward until it snaps.

Wipe up any residual water from the engine.

Disconnect the garden hose.

NOTE: It is recommended to fog the engine valves with XP-S LUBE. Contact your authorized Sea-Doo dealer.

Battery

Contact your authorized Sea-Doo dealer.

Engine Cooling System

Antifreeze should be replaced for the storage period to prevent antifreeze deterioration.

The antifreeze replacement and a density test should be performed by an authorized Sea-Doo dealer.

CAUTION: Improper antifreeze mixture might allow freezing of the liquid in the cooling system if vehicle is stored in area where freezing point is reached. This would seriously damage the engine. Failure to replace the antifreeze for storage may allow its degradation that could result in poor cooling when engine will be used.

Bilge Cleaning

The following steps should be performed to provide the watercraft enhanced protection.

Clean the bilge with hot water and detergent or with bilge cleaner. Rinse thoroughly. Lift front end of watercraft to completely drain bilge.

Anticorrosion Treatment

Wipe off any residual water in the engine compartment.

Spray XP-S LUBE or equivalent over metallic components in engine compartment.

WARNING

Do not lubricate the safety lanyard post.

Lubricate the throttle cable with XP-S LUBE or equivalent.

Drive Shaft Corrosion Protection

To give additional protection to drive shaft against possible corrosion in salt water conditions, it is recommended to bring the watercraft to an authorized Sea-Doo dealer for proper lubrication.

Final Steps

If any repairs are needed to body or to the hull, contact your authorized Sea-Doo dealer. For paint touch up of mechanical parts use BRP spray paint.

Apply a good quality marine wax to the body.

The seat and the seat extension should be partially left opened. This will prevent engine compartment condensation and possible corrosion.

If the watercraft is to be stored outside, cover it with an opaque tarpaulin to prevent sun rays and grime from affecting the plastic components, watercraft finish as well as preventing dust accumulation.

CAUTION: The watercraft should never be left in water for storage. Never leave the watercraft stored in direct sunlight. Never store watercraft in a plastic bag.

Preseason Preparation

Use the following chart.

Since technical skills and special tools are required, some operations should be performed by an authorized Sea-Doo dealer.

WARNING

Only perform procedures as detailed in this guide. It is recommended that the assistance of an authorized Sea-Doo dealer be periodically obtained on other components/systems not covered in this guide. Unless otherwise specified, engine must not be running and the safety lanyard must be removed from its post for all maintenance procedures. Components inside engine compartment may be hot. When component conditions seem less than satisfactory, replace with genuine BRP parts or approved equivalents.

Preseason Preparation Chart

NOTE: It is highly recommended that an authorized Sea-Doo dealer perform the annual safety inspection and factory campaigns in addition to the preseason preparation all at the same time.

OPERATIONS		TO BE PERFORMED BY
GENERAL	Lubrication/corrosion protection	Operator
	Spark plug replacement ⁽¹⁾	Dealer
ENGINE	Exhaust system condition and fasteners	Dealer
	Condition of seals and fasteners	Dealer
	Oil level	Dealer
COOLING SYSTEM	Inspection of cooling system coolant level, hoses and components if antifreeze was not changed for storage, drain and replace with new antifreeze.	Dealer
FUEL SYSTEM	Fuel filter replacement	Dealer
	Fuel injection sensors verification	Dealer
	Fuel system; check valves, lines, fasteners, pressurization ⁽²⁾	Dealer
	Filler neck, fuel tank and fuel cap condition ⁽²⁾	Dealer
	Fuel tank straps	Operator
	Refill fuel tank	Operator
ELECTRICAL SYSTEM	Battery condition/charging and reinstallation. Set the preferences in information center.	Dealer
	Battery, starter connections and routing ⁽²⁾	Dealer
	Monitoring beeper	Dealer
	Digitally encoded security system	Dealer
STEERING SYSTEM	Steering system adjustment/inspection ⁽²⁾	Dealer
O.P.A.S. SYSTEM	Check O.P.A.S. system condition	Dealer
PROPULSION SYSTEM	Shifter system condition and cable adjustment	Dealer
	VTS (Variable Trim System, if so equipped)	Dealer
	Propulsion system inspection	Dealer
HULL AND BODY	Inspection of drain plugs	Dealer
	Ski/wakeboard post and fasteners	Operator

(1) Before installing new spark plugs, it is suggested to burn the excess XP-S LUBE or equivalent by starting the engine using the old spark plugs.

(2) Safety item covered in the annual safety inspection.

TROUBLESHOOTING

The following chart is provided to help in diagnosing the probable source of simple troubles. You may be able to solve many of these problems rather quickly, but others may require the skills of a mechanical technician. In such cases, consult an authorized Sea-Doo dealer for servicing.

NOTE: For the definition of abbreviations used here, refer to *ABBREVIATIONS USED IN THIS MANUAL* section below.

Monitoring Beeper Coded Signals

NOTE: When the beeper sounds, also look the message displayed on the information center to obtain more details on the problem. Refer to *INFORMATION CENTER*.

CODED SIGNALS	POSSIBLE CAUSE	REMEDY
2 short beeps (while installing safety lanyard on post).	Confirms safety lanyard signal operation.	Engine can be started.
1 long beep (while installing safety lanyard on watercraft post).	Bad DESS system connection.	Reinstall safety lanyard cap correctly over post.
	Wrong safety lanyard.	Use a safety lanyard that has been programmed for the watercraft.
	Defective safety lanyard.	Use another programmed safety lanyard.
	Dried salt water in safety lanyard cap.	Clean safety lanyard cap to remove salt water.
	Defective DESS post.	Refer to an authorized Sea-Doo dealer.
	Improper operation of ECM or defective wiring harness.	
1 short beep followed by 1 long beep.	ECM has been mistakenly set to onboard diagnostic mode.	Remove and reinstall safety lanyard.
4 short beeps every 3 seconds interval for 4 hours.	Safety lanyard has been left on its post without starting engine or after engine was stopped.	To prevent battery discharge, remove the safety lanyard from its post.

CODED SIGNALS	POSSIBLE CAUSE	REMEDY
A 2 seconds beep every 15 minutes interval.	Watercraft is upside down.	Turn watercraft upright. Refer to <i>SPECIAL PROCEDURES</i> .
	Engine coolant temperature sensor or circuit malfunction.	Refer to an authorized Sea-Doo dealer.
	Exhaust temperature sensor or circuit malfunction.	
	Engine oil pressure sensor or circuit malfunction.	
	Battery voltage too high or too low	
	MATS sensor malfunction.	
	CPS sensor malfunction.	
	MATS sensor malfunction.	
	CAPS sensor malfunction.	
	Knock sensor malfunction.	
	TPS sensor malfunction.	
	Ignition coil malfunction.	
	Injectors malfunction.	
	Wrong ECU installed.	
	MAPS sensor malfunction.	
	TOPS valve solenoid or circuit malfunction.	
	Starter solenoid circuit malfunction.	
	Communication link fault detected by MPEM.	
ECM communication link message missing (detected by MPEM).		
Information center communication link message missing (detected by MPEM).		
Bilge pump circuit low or high voltage (if so equipped).		

CODED SIGNALS	POSSIBLE CAUSE	REMEDY
A 2 seconds beep every 5 minutes interval.	• Low fuel level.	Refill fuel tank. If problem persists, refer to an authorized Sea-Doo dealer.
	• Fuel tank level sensor or circuit malfunction.	Refer to an authorized Sea-Doo dealer.
Continuously beeps.	High engine temperature coolant.	See <i>ENGINE OVERHEATING</i> .
	High exhaust temperature.	Refer to an authorized Sea-Doo dealer.

INFORMATION CENTER MESSAGES

OBSERVATION	POSSIBLE CAUSE	REMEDY
The information center display abbreviated messages that I don't understand.	Some messages are useful navigational information and others may be system fault information.	Refer to <i>INFORMATION CENTER GAUGE</i> in <i>CONTROLS, COMPONENTS AND INSTRUMENTS FUNCTIONS</i> .
No numbers are displayed in the usual display and only P-XXXX numbers appear in the message area.	ECM has been mistakenly set to onboard diagnostic mode.	Remove and reinstall safety lanyard.

ENGINE WILL NOT START

OTHER OBSERVATION	POSSIBLE CAUSE	REMEDY
Engine does not turn over.	Safety lanyard removed.	Install cap over post.
	ECM does not recognize the safety lanyard.	Refer to an authorized Sea-Doo dealer.
	Turned over watercraft.	Refer to <i>CAPSIZED WATERCRAFT</i> in <i>SPECIAL PROCEDURES</i> .
	Burnt fuse: main, electric starter, MPEM or ECM.	Check wiring then replace fuse(s).
	Discharged battery.	Refer to an authorized Sea-Doo dealer.
	Battery connections, corroded or loose. Bad ground	Refer to an authorized Sea-Doo dealer.
	Water-flooded engine.	Refer to <i>WATER-FLOODED ENGINE</i> in <i>SPECIAL PROCEDURES</i> .
	Faulty sensor, MPEM or ECM.	Refer to an authorized Sea-Doo dealer.
	Seized engine.	Refer to an authorized Sea-Doo dealer.
	Seized jet pump.	Try to clean. Otherwise, refer to an authorized Sea-Doo dealer.
Engine turns slowly.	Loose battery cable connections.	Check/clean/tighten.
	Discharged or weak battery.	Refer to an authorized Sea-Doo dealer.
	Worn starter.	Refer to an authorized Sea-Doo dealer.

OTHER OBSERVATION	POSSIBLE CAUSE	REMEDY
Engine turns normally.	Fuel tank empty or water-contaminated.	Refill. Siphon and fill with fresh fuel.
	Fouled/defective spark plugs.	Replace.
	Fuel-flooded engine.	Refer to <i>FUEL-FLOODED ENGINE</i> in <i>SPECIAL PROCEDURES</i> .
	Water-flooded engine.	Refer to <i>WATER-FLOODED ENGINE</i> in <i>SPECIAL PROCEDURES</i> .
	Faulty component in the engine management system or faulty connection.	Refer to an authorized Sea-Doo dealer.
	Disconnected or faulty fuel pump.	Try reconnecting fuel pump connector. Refer to an authorized Sea-Doo dealer.
	Blown fuse.	Check wiring then replace fuse(s).

Engine Misfires, Misinjects, Runs Irregularly

OTHER OBSERVATION	POSSIBLE CAUSE	REMEDY
Weak spark.	Fouled/defective/worn spark plugs.	Replace.
	Faulty ignition coil(s) or ECM.	Refer to an authorized Sea-Doo dealer.
Lean fuel mixture.	Fuel: Level too low, stale or water-contaminated.	Siphon and/or refill.
	Clogged injectors.	Refer to an authorized Sea-Doo dealer.
	Defective sensor or ECM.	Refer to an authorized Sea-Doo dealer.
Rich fuel mixture (high fuel consumption).	Defective sensor or ECM.	Refer to an authorized Sea-Doo dealer.

Engine Smoke

OTHER OBSERVATION	POSSIBLE CAUSE	REMEDY
	Oil level too high.	Refer to an authorized Sea-Doo dealer. Refer to an authorized Sea-Doo dealer.
	Internal engine damage.	
	Water ingestion, coolant leak or damaged cylinder head gasket	

Engine Overheats

OTHER OBSERVATION	POSSIBLE CAUSE	REMEDY
	Engine coolant level too low.	Refer to <i>LIQUIDS</i> .
	Clogged jet pump water intake.	Clean.
	Clogged exhaust cooling system.	Flush exhaust cooling system.
	Quick connect adapter left in flushing connector.	Remove adapter from flushing connector and retry watercraft. If problem persists, refer to an authorized Sea-Doo dealer.

Engine Pinging or Knocking

OTHER OBSERVATION	POSSIBLE CAUSE	REMEDY
	Knock sensor malfunction.	Refer to an authorized Sea-Doo dealer.

Engine Lacks Acceleration or Power

OTHER OBSERVATION	POSSIBLE CAUSE	REMEDY
	Engine oil level too high.	Refer to an authorized Sea-Doo dealer.
	Weak spark.	Refer to <i>ENGINE MISFIRES, RUNS IRREGULARLY</i> .
	The monitoring system put the watercraft in limp home mode due to a component malfunction.	Refer to <i>MONITORING SYSTEM</i> in <i>SPECIAL PROCEDURES</i> .
	Engine damaged by water ingestion.	Refer to an authorized Sea-Doo dealer.
	Clogged injectors.	Refer to an authorized Sea-Doo dealer.
	Low fuel pressure.	Refer to an authorized Sea-Doo dealer.
	Water in fuel.	Siphon and replace.

Watercraft Can Not Reach Top Speed

OTHER OBSERVATION	POSSIBLE CAUSE	REMEDY
	VTS is adjusted to suit other riding conditions (if so equipped).	Readjust to try another setting.
Cavitation.	Jet pump water intake clogged.	Clean.
	Damaged impeller or worn-out wear ring.	Replace. Refer to an authorized Sea-Doo dealer.
	The SEA-DOO Learning Key™ safety lanyard is used which does not allow watercraft to reach its top speed.	Use a regular safety lanyard.
	The monitoring system put the watercraft in limp home mode due to a component malfunction.	Refer to <i>MONITORING SYSTEM</i> in <i>SPECIAL PROCEDURES</i> .

OTHER OBSERVATION	POSSIBLE CAUSE	REMEDY
Engine and/or EMS	The Sea-Doo learning key™ safety lanyard is used which purposely does not allow watercraft to reach its top speed.	Use a regular safety lanyard
	The monitoring system put the watercraft in limp home mode due to a component malfunction.	Refer to <i>MONITORING SYSTEM</i> in <i>SPECIAL PROCEDURES</i> .
	Faulty supercharger and/or intercooler (if so equipped)	Refer to an authorized Sea-Doo dealer.
Models with sliding vanes: O.P.A.S.™ side vanes do not go up while watercraft is at speed.	Clogged filter, square rings damaged, leakage in hoses or mechanical malfunction.	Refer to an authorized Sea-Doo dealer.
Models with sliding vanes: O.P.A.S. side vanes do not go down while engine is at idle.	Broken spring inside side vane cylinder.	Refer to an authorized Sea-Doo dealer.

Engine RPM Gradually Decreases and Engine Stops

OTHER OBSERVATION	POSSIBLE CAUSE	REMEDY
	Out of fuel.	Refill.
	CPS sensor malfunction.	Refer to an authorized Sea-Doo dealer.
	TOPS malfunction.	Refer to an authorized Sea-Doo dealer.

O.P.A.S. System Faults (models with sliding vanes)

OTHER OBSERVATION	POSSIBLE CAUSE	REMEDY
Watercraft is more responsive than usual while turning.	Side vanes do not go up while watercraft is at speed.	Refer to an authorized Sea-Doo dealer.
Watercraft pulls on one side.	One side vane does not go up while watercraft is at speed.	Refer to an authorized Sea-Doo dealer.
O.P.A.S. side vanes do not go up while watercraft is at speed.	Clogged filter, square rings damaged, leakage in hoses or mechanical malfunction.	Refer to an authorized Sea-Doo dealer.
O.P.A.S. side vanes do not go down while engine is at idle.	Broken spring inside side vane cylinder.	Refer to an authorized Sea-Doo dealer.

Abnormal Noise from Propulsion System

OTHER OBSERVATION	POSSIBLE CAUSE	REMEDY
Cavitation.	Weeds or debris jammed around impeller.	Clean and check for damage.
	Damaged impeller shaft or drive shaft.	Refer to an authorized Sea-Doo dealer.
	Water intrusion in jet pump causing bearing seizure.	Refer to an authorized Sea-Doo dealer.

SPECIFICATIONS

VEHICLE		GTX 4-TEC SERIES/WAKE/RXT
ENGINE		
Type	BRP-ROTAX 1503, 4 stroke. Single Over Head Camshaft (SOHC), liquid cooled	
Number of cylinder	3 in line	
Number of valve	12 valves (4 per cylinder) with hydraulic lifters (no adjustment)	
Displacement	1494 cc (91.2 cu. in)	
Induction type	NA Models: Naturally-aspirated Supercharged and Supercharged Intercooled Models: Mechanically-driven supercharger	
Bore	100 mm (3.9 in)	
Stroke	63.4 mm (2-1/2 in)	
Compression ratio	NA Models: 10.6:1 Supercharged Models: 8.1:1 Supercharged Intercooled Models: 8.4:1	
Lubrication	Type	Dry sump (2 oil pumps). Replaceable oil filter. Water-cooled oil cooler
	Oil type	Refer to <i>LIQUIDS</i> section
Exhaust system	Water cooled/water injected. Direct flow from propulsion unit	
Rev limiter setting	NA and Supercharged Models: 7650 RPM Supercharged Intercooled Models:8000 RPM	
COOLING SYSTEM		
Type	Liquid cooled. Closed circuit (see also exhaust system)	
Coolant	Ethylene-glycol 50%/50% antifreeze/demineralized water. Coolant containing corrosion inhibitors for internal combustion aluminum engines	
ELECTRICAL SYSTEM		
Magneto generator output	360 W @ 6000 RPM	
Ignition system type	Digital inductive type	
Ignition timing	Not adjustable	
Spark plug	Make and type	NGK, DCPR8E
	Gap	0.75 mm (.030 in)
	Quantity	3
Starting system	Electric starter	
Battery	12 V, 30 A•h. Electrolyte type	
Fuses	Refer to <i>MAINTENANCE</i>	

VEHICLE		GTX 4-TEC SERIES/WAKE/RXT
FUEL SYSTEM		
Fuel	RECOMMENDED FOR OPTIMUM PERFORMANCE	
	Type	Premium unleaded gasoline
	Minimum octane number	Inside North America: 91 (R + M) / 2 Outside North America: 95 RON
	MINIMUM ALLOWED	
	Type	Regular unleaded gasoline
	Minimum octane number	Inside North America: 87 (R + M) / 2 Outside North America: 91 RON
Fuel injection		Rotax EMS (engine management system). Multipoint Fuel Injection. Single throttle body (52 mm (2.04 in))
PROPULSION		
Propulsion system		BRP Formula pump
Jet pump type		Axial flow, single stage. Greased bearings
Transmission		Direct drive
Reverse system		Yes
O.P.A.S. system		Yes
Pivoting angle of direction (nozzle)		~ 20°
Minimum required water level for jet pump		90 cm (3 ft) underneath the lowest rear portion of hull
DIMENSIONS		
Number of passengers ¹		3
Overall length	GTI Series	322.5 cm (127 in)
	GTX Series	331 cm (130 in)
	RXT Models	331 cm (130 in)
Overall width	GTI Series	124.5 cm (49 in)
	Other	122 cm (48 in)
Overall height		113 cm (44 in)

VEHICLE		GTX 4-TEC SERIES/WAKE/RXT	
Weight	GTI	Base	333 kg (732 lb)
		Rental	340 kg (747 lb)
		Sport	340 kg (747 lb)
	GTX	NA	384 kg (847 lb)
		BV	389 kg (857 lb)
		WAKE	393 kg (867 lb)
		LTD	397 kg (875 lb)
	RXT		394 kg (869 lb)
Load limit (passengers + luggage)			272 kg (600 lb)
CAPACITIES			
Engine oil		3 L (2.7 U.S. qt) oil change w/filter 4.5 L (4.1 U.S. qt) total	
Cooling system (coolant)		5.5 L (5 U.S. qt) total	
Fuel tank (including reserve)		60 L (15.9 U.S. gal)	
Fuel tank reserve (from low level signal)		15 L (4 U.S. gal)	

(1) Refer to load limit.

BRP reserves the right to make changes in design and specifications and/or to make additions to, or improvements in its products without imposing any obligation upon itself to install them on its products previously manufactured.

VEHICLE		RXP
ENGINE		
Type		BRP-ROTAX 1503, 4 stroke. Single Over Head Camshaft (SOHC), liquid cooled
Number of cylinder		3 in line
Number of valve		12 valves (4 per cylinder) with hydraulic lifters (no adjustment)
Displacement		1494 cc (91.2 cu. in)
Induction type		Mechanically-driven supercharger with intercooler supplied directly from propulsion unit
Bore		100 mm (3.9 in)
Stroke		63.4 mm (2-1/2 in)
Compression ratio		8.4:1
Lubrication	Type	Dry sump (2 oil pumps). Replaceable oil filter. Water-cooled oil cooler
	Oil type	Refer to LIQUIDS section
Exhaust system		Water cooled/water injected. Direct flow from propulsion unit
Rev limiter setting		8000 RPM
COOLING SYSTEM		
Type		Liquid cooled. Closed circuit (see also exhaust system)
Coolant		Ethylene-glycol 50%/50% antifreeze/demineralized water. Coolant containing corrosion inhibitors for internal combustion aluminum engines
ELECTRICAL SYSTEM		
Magneto generator output		360 W @ 6000 RPM
Ignition system type		Digital inductive type
Ignition timing		Not adjustable
Spark plug	Make and type	NGK, DCPR8E
	Gap	0.75 mm (.030 in)
	Quantity	3
Starting system		Electric starter
Battery		12 V, 30 A•h. Electrolyte type
Fuses		Refer to <i>MAINTENANCE</i>

VEHICLE	RXP	
FUEL SYSTEM		
Fuel	RECOMMENDED FOR OPTIMUM PERFORMANCE	
	Type Premium unleaded gasoline	
	Minimum octane number Inside North America: 91 (R + M) / 2 Outside North America: 95 RON	
	MINIMUM ALLOWED	
	Type Regular unleaded gasoline	
Minimum octane number Inside North America: 87 (R + M) / 2 Outside North America: 91 RON		
Fuel injection	Rotax EMS (engine management system). Multipoint Fuel Injection. Single throttle body (52 mm (2.04 in))	
PROPULSION		
Propulsion system	BRP Formula pump	
Jet pump type	Axial flow, single stage. Greased bearings	
Transmission	Direct drive	
Reverse system	Yes	
O.P.A.S. system	Yes	
Pivoting angle of direction (nozzle)	~ 20°	
Minimum required water level for jet pump	90 cm (3 ft) underneath the lowest rear portion of hull	
DIMENSIONS		
Number of passengers ¹	2	
Overall length	307 cm (121 in)	
Overall width	122 cm (48 in)	
Overall height	109 cm (43 in)	
Weight	359 kg (792 lb)	
Load limit (passengers + luggage)	181 kg (400 lb)	

VEHICLE	RXP
CAPACITIES	
Engine oil	3 L (2.7 U.S. qt) oil change w/filter 4.5 L (4.1 U.S. qt) total
Cooling system (coolant)	5.5 L (5 U.S. qt) total
Fuel tank (including reserve)	60 L (15.9 U.S. gal)
Fuel tank reserve (from low level signal)	15 L (4 U.S. gal)

(1) Refer to load limit.

BRP reserves the right to make changes in design and specifications and/or to make additions to, or improvements in its products without imposing any obligation upon itself to install them on its products previously manufactured.

ABBREVIATIONS USED IN THIS MANUAL

ABBREVIATION	DESCRIPTION
API	American petroleum institute
CARB	California air resource board
DESS	Digitally encoded security system
ECM	Engine control module
ECU	Electronic control unit
EMS	Engine management system
E.I.N.	Engine identification number
EPA	Environmental protection agency
LCD	Liquid Crystal Display
LED	Light-emitting diode
MPEM	Multi-purpose electronic module
MPH	Mile per hour
N.A.	Not applicable
NA engine	Naturally-aspirated engine
O.P.A.S.	Off-power assisted steering
PFD	Personal flotation device
P/N	Part number
TOPS	Tip-over protection system
VTS	Variable trim system

WARRANTY

NORTH AMERICA

USA (Except Puerto Rico)	BRP US Inc. 7575 Bombardier Court Wausau, WI. 54401 Phone: (715) 848-4957 Fax: (715) 847-6879 www.BRP.com
CANADA	BOMBARDIER RECREATIONAL PRODUCTS INC. 75 J.A. Bombardier Sherbrooke, QC J1L 1W3 Phone: (819) 566-3366 Fax: (819) 566-3062 www.brp.com

If your Sea-Doo watercraft requires warranty service, you should take it to any authorized Sea-Doo dealer. Be sure to bring your warranty registration card or other valid proof of the original date of purchase. If a question or problem arises regarding warranty, first contact the service manager or owner of the Sea-Doo dealership.

To find the nearest authorized Sea-Doo dealer, dial: 1 800 882-2900.

NOTE: If outside Canada or USA, consult your local authorized Sea-Doo distributor.

BRP NORTH AMERICA LIMITED WARRANTY: 2006 SEA-DOO® PERSONAL WATERCRAFT

1. SCOPE

Bombardier Recreational Products Inc. (“BRP”)* warrants its model-year 2006 Sea-Doo personal watercraft from defects in material or workmanship for the period and under the conditions described below.

All genuine BRP parts and accessories, installed by an authorized BRP dealer (as hereinafter defined) at the time of delivery of the Sea-Doo personal watercraft, carry the same warranty as that of the personal watercraft.

A GPS receiver may be supplied by BRP as standard equipment on certain 2006 Sea-Doo personal watercraft. The GPS receiver is covered by the limited warranty issued by the GPS receiver’s manufacturer and is not covered by this limited warranty.

Use of the product for racing or any other competitive activity, at any point, even by a prior owner, will render this warranty null and void.

2. WARRANTY COVERAGE DURATION

This warranty will be in effect from the date of delivery to the first retail consumer or the date the product is first put into use, whichever occurs first and for a period of:

- a) TWELVE (12) CONSECUTIVE MONTHS for private use owners.
- b) FOUR (4) CONSECUTIVE MONTHS for commercial use owners, except for the Sea-Doo personal watercraft models 256A and 256B, which are covered for TWELVE (12) CONSECUTIVE MONTHS for commercial use owners. A personal watercraft is used commercially when it is used in connection with generating income or any work or employment during any part of the warranty period. A personal watercraft is also used commercially when, at any point during the warranty period, it has commercial tags or is licensed for commercial use.
- c) In addition to the above, the emission related components providing input to emission control (see list below) are covered for TWENTY-FOUR (24) CONSECUTIVE MONTHS OR 200 HOURS OF ENGINE USE whichever occurs first.

EMISSION RELATED COMPONENTS
Throttle Position Sensor (TPS)
Air Temperature sensor (ATS)
Air Pressure Sensor (APS)

The repair or replacement of parts or the performance of service under this warranty does not extend the life of this warranty beyond its original expiration date.

For Sea-Doo personal watercraft produced for sale in the states of California or New York, that are originally sold to a resident or subsequently warranty registered to a resident in the state of California or New York, please also refer to the applicable California and New York Emissions Control Warranty Statement.

3. CONDITIONS TO HAVE WARRANTY COVERAGE

This warranty coverage is available only on Sea-Doo personal watercraft purchased as new and unused by its first owner from a BRP dealer authorized to distribute Sea-Doo products in the country in which the sale occurred ("BRP dealer"), and then only after the BRP specified predelivery inspection process is completed and documented. Warranty coverage only becomes available upon proper registration of the product by an authorized BRP dealer. Moreover, this warranty coverage is only available if the personal watercraft is purchased in the country in which the purchaser resides. BRP will not honor this limited warranty to any private use owner or commercial use owner if the preceding conditions have not been met. Such limitations are necessary in order to allow BRP to preserve the safety of its products, consumers and the general public.

Routine maintenance outlined in the Operator's Guide must be timely performed in order to maintain warranty coverage. BRP reserves the right to make warranty coverage contingent upon proof of proper maintenance.

4. WHAT TO DO TO OBTAIN WARRANTY COVERAGE

The customer must notify an authorized servicing BRP dealer within two (2) days of the appearance of a defect, and provide it with reasonable access to the product and reasonable opportunity to repair it. The customer must also present to the authorized BRP dealer, proof of purchase of the product and must sign the repair/work order prior to the start of the repair in order to validate the warranty repair. All parts replaced under this limited warranty become the property of BRP.

5. WHAT BRP WILL DO

BRP's obligations under this warranty are limited to, at its sole discretion, repairing parts found defective under normal use, maintenance and service, or replacing such parts with new genuine BRP parts without charge for parts and labor, at any authorized BRP dealer.

BRP reserves the right to improve or modify products from time to time without assuming any obligation to modify products previously manufactured.

6. EXCLUSIONS

The following are not warranted under any circumstances:

- Normal wear and tear;
- Routine maintenance items, tune ups, adjustments;
- Damage caused by failure to provide proper maintenance and/or storage, as described in the Operator's Guide;
- Damage resulting from removal of parts, improper repairs, service, maintenance, modifications or use of parts not manufactured or approved by BRP or resulting from repairs done by a person that is not an authorized servicing BRP dealer;
- Damage caused by abuse, abnormal use, neglect, or operation of the product in a manner inconsistent with the recommended operation described in the Operator's Guide;
- Damage resulting from accident, submersion, fire, theft, vandalism or any act of God;

- Operation with fuels, oils or lubricants which are not suitable for use with the product (see the Operator's Guide);
- Water damages caused by water ingestion;
- Damages related to gel coat finish including but not limited to cosmetic gel coat finish, blisters or fiberglass delamination caused by blisters, crazing, spider of hairline cracks; and
- Incidental or consequential damages, or damages of any kind including without limitation towing, storage, telephone, rental, taxi, inconvenience, insurance coverage, loan payments, loss of time, loss of income.

7. LIMITATIONS OF LIABILITY

THIS WARRANTY IS EXPRESSLY GIVEN AND ACCEPTED IN LIEU OF ANY AND ALL OTHER WARRANTIES, EXPRESSED OR IMPLIED, INCLUDING WITHOUT LIMITATION ANY WARRANTY OF MERCHANTABILITY OR FITNESS FOR A PARTICULAR PURPOSE. TO THE EXTENT THAT THEY CANNOT BE DISCLAIMED, THE IMPLIED WARRANTIES ARE LIMITED IN DURATION TO THE LIFE OF THE EXPRESS WARRANTY. INCIDENTAL AND CONSEQUENTIAL DAMAGES ARE EXCLUDED FROM COVERAGE UNDER THIS WARRANTY. SOME STATES/PROVINCES DO NOT ALLOW FOR THE DISCLAIMERS, LIMITATIONS AND EXCLUSIONS IDENTIFIED ABOVE, AS A RESULT, THEY MAY NOT APPLY TO YOU. THIS WARRANTY GIVES YOU SPECIFIC RIGHTS, AND YOU MAY ALSO HAVE OTHER LEGAL RIGHTS WHICH MAY VARY FROM STATE TO STATE, OR PROVINCE TO PROVINCE.

Neither the distributor, any BRP dealer nor any other person has been authorized to make any affirmation, representation or warranty regarding the product, other than those contained in this limited warranty, and if made, shall not be enforceable against BRP. BRP reserves the right to modify this warranty at any time, being understood that such modification will not alter the warranty conditions applicable to the products sold while this warranty is in effect.

8. TRANSFER

If the ownership of a product is transferred during the warranty coverage period, this warranty shall also be transferred and be valid for the remaining coverage period provided that BRP is notified of such transfer of ownership in the following way:

- a) The former owner contacts BRP (at the phone number provided below) or an authorized BRP dealer and gives the coordinates of the new owner; or
- b) BRP or an authorized BRP dealer receives a proof that the former owner agreed to the transfer of ownership, in addition to the coordinates of the new owner.

9. CONSUMER ASSISTANCE

In the event of a controversy or a dispute in connection with this BRP limited warranty, BRP suggests that you try to resolve the issue at the dealership level. We recommend discussing the issue with the authorized dealer's service manager or owner.

If the issue has not yet been resolved, please submit your complaint in writing or call the appropriate number below:

IN CANADA:

BOMBARDIER RECREATIONAL
PRODUCTS INC.
CONSUMER SERVICES GROUP
VALCOURT QC J0E 2L0
Tel: (819) 566-3366

IN USA:

BRP US INC.
CONSUMER SERVICES GROUP
7575 BOMBARDIER COURT
WAUSAU WI 54401
Tel: (715) 848-4957

* In the USA, products are distributed and serviced by BRP US Inc.

© 2005 Bombardier Recreational Products Inc. All rights reserved.

® Registered trademark and TM trademark of Bombardier Recreational Products Inc.

CALIFORNIA AND NEW YORK EMISSION CONTROL WARRANTY STATEMENT FOR MODEL-YEAR 2006 SEA-DOO® PERSONAL WATERCRAFT WITH 4-TEC™ ENGINES OR 4-TEC DT ENGINES OR 4-TEC SC ENGINES OR 4-TEC IC ENGINES

For California, your Sea-Doo watercraft has a special environmental label required by the California Air Resources Board. The label has 1, 2, 3 or 4 stars. A hangtag, provided with your personal watercraft or sport boat, describes the meaning of the star rating system.

The Star Label means Cleaner Marine Engines



F18L3CQ



The Symbol for Cleaner Marine Engines:

Cleaner Air and Water

For a healthier lifestyle and environment.

Better Fuel Economy

Burns up to 30 - 40 percent less gas and oil than conventional carbureted two-stroke engines, saving money and resources.

Longer Emission Warranty

Protects consumer for worry free operation

One Star - Low-Emission

The one-star label identifies personal watercraft, outboard, sterndrive and inboard engines that meet the Air Resources Board's Personal Watercraft and Outboard marine engine 2001 exhaust emission standards. Engines meeting these standards have 75% lower emissions than conventional carbureted two-stroke engines. These engines are equivalent to the U.S. EPA's 2006 standards for marine engines.

Two Stars - Very Low Emission

The two-star label identifies personal watercraft, outboard, sterndrive and inboard engines that meet the Air Resources Board's Personal Watercraft and Outboard marine engine 2004 exhaust emission standards. Engines meeting these standards have 20% lower emissions than One Star - Low-Emission engines.

Three Stars - Ultra Low Emission

The three-star label identifies engines that meet the Air Resources Board's Personal Watercraft and Outboard marine engine 2008 exhaust emission standards or the Sterndrive and Inboard marine engine 2003 exhaust emission standards. Engines meeting these standards have 65% lower emissions than One Star - Low Emission engines.

Four Stars - Super Ultra Low Emission

The four-star label identifies engines that meet the Air Resources Board's Stern-drive and Inboard marine engine 2009 exhaust emission standards. Personal Watercraft and Outboard marine engines may also comply with these standards. Engines meeting these standards have 90% lower emissions than One Star - Low Emission engines.

For more information: Cleaner Watercraft – Get the Facts
1-800-END-SMOG
www.arb.ca.gov

YOUR EMISSION CONTROL WARRANTY RIGHTS AND OBLIGATIONS

The California Air Resources Board, the New York State Department of Environmental Conservation, and BRP US Inc. ("BRP")* on behalf of Bombardier Recreational Products Inc. are pleased to explain the emission control system warranty on your model-year 2006 Sea-Doo personal watercraft. In the states of California and New York, new personal watercraft engines must be designed, built and equipped to meet the States stringent anti-smog standards. BRP must warrant the emission control system on your personal watercraft engine for the periods of time listed below provided there has been no abuse, neglect or improper maintenance of your personal watercraft engine.

Your emission control system may include parts such as the carburetor or fuel injection system, the ignition system and catalytic converter. Also included may be hoses, belts, connectors and other emission-related assemblies.

Where a warrantable condition exists, BRP will repair your personal watercraft engine at no cost to you including diagnosis, parts and labor provided that such work is performed by an authorized BRP dealer.

Manufacturer's Limited Warranty Coverage

This emission warranty covers model year 2006 Sea-Doo personal watercraft certified and produced by BRP for sale in the states of California or New York, that are originally sold to a resident or subsequently warranty registered to a resident in the state of California or New York. The BRP limited warranty conditions for Sea-Doo personal watercraft are still applicable to these models with the necessary modifications.

Select emission control parts of your 2006 Sea-Doo personal watercraft are warranted from the date of delivery to the first retail consumer for a period of 4 years, or for 250 hours of use, whichever occurs first. However, warranty coverage based on the hourly period is only permitted for personal watercraft equipped with the appropriate hour meters or their equivalent. If any emission-related part on your engine is defective under warranty, the part will be repaired or replaced by BRP.

Parts covered for 2006 Sea-Doo personal watercraft with 4-TEC engines or 4-TEC DT engines or 4-TEC SC engines or 4-TEC IC engines:

Digital Linear Actuator (low idle control)	All Fuel System Components
Throttle Position Sensor	Spark Plugs
Intake Manifold Air Pressure Sensor	Ignition Coils
Intake Manifold Air Temperature Sensor	Piston and Rings
Engine Temperature Sensor	Intake and Exhaust Valve Gear/Train
Knock Sensor	Valves, Valve Guides and Valve Guide Sealing
Emission Control Unit	Crankcase Ventilation Valve
Injectors	Wire Harness and Connectors
Fuel Pressure Regulator	Emission Related Seals, Gaskets and Hoses
Intake manifold ¹	Exhaust manifold
Supercharger	

The emission warranty covers damage to other engine components that is caused by the failure of a warranted part.

The BRP Operator's Guide provided contains written instructions for the proper maintenance and use of your personal watercraft. All emission warranty parts are warranted by BRP for the entire warranty period of the personal watercraft, unless the part is scheduled for replacement as required maintenance in the Operator's Guide.

Emission warranty parts that are scheduled for replacement, as required maintenance, are warranted by BRP for the period of time before the first scheduled replacement date for that part. Emission warranty parts that are scheduled for regular inspection, but not regular replacement, are warranted by BRP for the entire warranty period of the personal watercraft. Any emission warranty part repaired or replaced under the terms of this warranty statement is warranted by BRP for the remainder of the warranty period of the original part. All parts replaced under this limited warranty become the property of BRP.

Maintenance receipts and records should be transferred to each subsequent owner of the personal watercraft.

¹ The Intercooler is included in the intake manifold.

Owner's Warranty Responsibilities

As the personal watercraft owner, you are responsible for the performance of the required maintenance listed in your Operator's Guide. BRP recommends that you retain all receipts covering maintenance on your personal watercraft engine, but BRP cannot deny warranty solely for the lack of receipts or your failure to ensure the performance of all scheduled maintenance.

As the personal watercraft engine owner, you should however be aware that BRP may deny you warranty coverage if your personal watercraft engine or a part has failed due to abuse, neglect, improper maintenance or unapproved modifications.

You are responsible for presenting your personal watercraft engine to an authorized BRP dealer as soon as a problem exists. The warranty repairs will be completed in a reasonable amount of time, not to exceed 30 days.

If you have any questions regarding your warranty rights and responsibilities or for the name and location of the nearest authorized BRP dealer you should contact the Consumer Services Group at 1-715-848-4957.

* In the USA, products are distributed and serviced by BRP US Inc.

© 2005 Bombardier Recreational Products Inc. All rights reserved.

® Registered trademark and TM trademark of Bombardier Recreational Products Inc.

BRP INTERNATIONAL LIMITED WARRANTY: 2006 SEA-DOO® PERSONAL WATERCRAFT

1. SCOPE

Bombardier Recreational Products Inc. ("BRP") warrants its model-year 2006 Sea-Doo personal watercraft from defects in material or workmanship for the period described below.

All genuine BRP parts and accessories, installed by an authorized BRP distributor/dealer (as hereinafter defined) at the time of delivery of the Sea-Doo personal watercraft, carry the same warranty as that of the personal watercraft.

Use of the product for racing or any other competitive activity, at any point, even by a prior owner will render this warranty null and void.

2. WARRANTY COVERAGE DURATION

This warranty will be in effect from the date of delivery to the first retail consumer or the date the product is first put into use, whichever occurs first and for a period of:

- a) TWELVE (12) CONSECUTIVE MONTHS, for private recreational use.
- b) FOUR (4) CONSECUTIVE MONTHS, for commercial use, except for the Sea-Doo personal watercraft models 256A and 256B, which are covered for TWELVE (12) CONSECUTIVE MONTHS for commercial use owners. A personal watercraft is used commercially when it is used in connection with generating income or any work or employment during any part of the warranty period. A personal watercraft is also used commercially when, at any point during the warranty period, it has commercial tags or is licensed for commercial use.

The repair or replacement of parts or the performance of service under this warranty does not extend the life of this warranty beyond its original expiration date.

3. CONDITIONS TO HAVE WARRANTY COVERAGE

This warranty coverage is available only on Sea-Doo personal watercraft purchased as new and unused by its first owner from a BRP distributor/dealer authorized to distribute Sea-Doo products in the country in which the sale occurred (hereinafter "BRP distributor/dealer"), and then only after the BRP specified pre-delivery inspection process is completed and documented.

Warranty coverage only becomes available upon proper registration of the product by a BRP distributor/dealer. Such limitations are necessary in order to allow BRP to preserve the safety of its products, consumers and the general public.

Routine maintenance outlined in the Operator's Guide must be timely performed in order to maintain warranty coverage. BRP reserves the right to make warranty coverage contingent upon proof of proper maintenance.

4. WHAT TO DO TO OBTAIN WARRANTY COVERAGE

The customer must notify a servicing BRP distributor/dealer within two (2) days of the appearance of a defect, and provide it with reasonable access to the product and reasonable opportunity to repair it. The customer must also present to the BRP distributor/dealer, proof of purchase of the product and must sign the repair/work order prior to the start of the repair in order to validate the warranty repair. All parts replaced under this limited warranty become the property of BRP.

5. WHAT BRP WILL DO

BRP's obligations under this warranty are limited to, at its sole discretion, repairing parts found defective under normal use, maintenance and service, or replacing such parts with new genuine BRP parts without charge for parts and labor, at any authorized BRP distributor/dealer.

BRP reserves the right to improve or modify products from time to time without assuming any obligation to modify products previously manufactured.

6. EXCLUSIONS

The following are not warranted under any circumstances:

- Normal wear and tear;
- Routine maintenance items, tune ups, adjustments;
- Damage caused by failure to provide proper maintenance and/or storage, as described in the Operator's Guide;
- Damage resulting from removal of parts, improper repairs, service, maintenance, modifications or use of parts not manufactured or approved by BRP or resulting from repairs done by a person that is not an authorized servicing BRP distributor/ dealer;
- Damage caused by abuse, abnormal use, neglect or operation of the product in a manner inconsistent with the recommended operation described in the Operator's Guide;
- Damage resulting from accident, submersion, fire, theft, vandalism or any act of God;
- Operation with fuels, oils or lubricants which are not suitable for use with the product (see the Operator's Guide);
- Water damages caused by water ingestion;
- Damages related to gel coat finish including but not limited to cosmetic gel coat finish, blisters or fiberglass delamination caused by blisters, crazing, spider or hairline cracks; and
- Incidental or consequential damages, or damages of any kind including without limitation towing, storage, telephone, rental, taxi, inconvenience, insurance coverage, loan payments, loss of time, loss of income.

7. LIMITATIONS OF LIABILITY

THIS WARRANTY IS EXPRESSLY GIVEN AND ACCEPTED IN LIEU OF ANY AND ALL OTHER WARRANTIES, EXPRESSED OR IMPLIED, INCLUDING WITHOUT LIMITATION ANY WARRANTY OF MERCHANTABILITY OR FITNESS FOR A PARTICULAR PURPOSE. TO THE EXTENT THAT THEY CANNOT BE DISCLAIMED, THE IMPLIED WARRANTIES ARE LIMITED IN DURATION TO THE LIFE OF THE EXPRESS WARRANTY. INCIDENTAL AND CONSEQUENTIAL DAMAGES ARE EXCLUDED FROM COVERAGE UNDER THIS WARRANTY. SOME JURISDICTIONS DO NOT ALLOW FOR THE DISCLAIMERS, LIMITATIONS AND EXCLUSIONS IDENTIFIED ABOVE, AS A RESULT, THEY MAY NOT APPLY TO YOU. THIS WARRANTY GIVES YOU SPECIFIC RIGHTS, AND YOU MAY ALSO HAVE OTHER LEGAL RIGHTS WHICH MAY VARY FROM COUNTRY TO COUNTRY.

Neither the BRP distributor nor any other person has been authorized to make any affirmation, representation or warranty regarding the product, other than those contained in this limited warranty, and if made, shall not be enforceable against BRP.

BRP reserves the right to modify this warranty at any time, being understood that such modification will not alter the warranty conditions applicable to the products sold while this warranty is in effect.

8. TRANSFER

If the ownership of a product is transferred during the warranty coverage period, this warranty shall also be transferred and be valid for the remaining coverage period provided that BRP is notified of such transfer of ownership in the following way:

BRP or an authorised BRP distributor/dealer receives a proof that the former owner agreed to the transfer of ownership, in addition to the coordinates of the new owner. The distributor will then forward this information directly to BRP.

9. CONSUMER ASSISTANCE

- a) In the event of a controversy or a dispute in connection with this BRP limited warranty, BRP suggests that you try to resolve the issue at the dealership level. We recommend discussing the issue with the authorised dealer's service manager or owner.
- b) If further assistance is required, the distributor's service department should be contacted in order to resolve the matter.
- c) If the matter still remains unresolved then contact BRP by writing to us at the address listed below.

BOMBARDIER RECREATIONAL PRODUCTS INC.
CONSUMER SERVICES GROUP
VALCOURT QC J0E 2L0
Tel: (819) 566-3366

© 2005 Bombardier Recreational Products Inc. All rights reserved.

® Registered trademark and ™ trademark of Bombardier Recreational Products Inc.

DECLARATION CE OF CONFORMITY



DECLARATION **CE** OF CONFORMITY

Application of Council Directives:	Directive 2003/44/EC Recreational – craft
Relevant Directive(s):	Directive 89/336/CEE Electromagnetic compatibility
Relevant Harmonized Standard(s):	ISO 13590
Manufacturers:	Bombardier Recreational Products Inc. (“BRP”)
Manufacturers address:	726 St-Joseph, Valcourt, QC J0E 2L0
Product type:	Personal watercraft, inshore category C
Notified body:	International Marine Certification Institute Trèves Centre, rue de Trèves 45 1040 Brussels, Belgium
EC certificate:	EXBORP001: GTI, GTI SE, GTX, GTX WAKE EXBORP002: GTX LTD, RXP, RXT

I, the undersigned, hereby declare that the product specified above conforms to the above Directive(s) and Standard(s).

Name of signatory:

Fernando Garcia

Title of signatory on behalf of Bombardier Recreational Products Inc. (“BRP”):

Director –Public and Regulatory – Affairs
Sea-Doo Sport Boats

PRIVACY INFORMATION

We wish to inform you that your coordinates will be used for safety and warranty purposes. Sometimes, we also use the coordinates of our clients to inform them about our products and to present them offers. Should you prefer not to receive information on our products, services and offers, please let us know by writing to the address below.

Also note that, from time to time, carefully selected and trustworthy organizations may be permitted to use the coordinates of our clients to promote quality products and services. If you prefer not to have your name and address released, please let us know by writing to the address below:

Bombardier Recreational Products Inc.
Warranty Department
75 J.A. Bombardier Street
Sherbrooke, Québec
J1L 1W3 Canada

Fax Number (819) 566-3590

CHANGE OF ADDRESS/OWNERSHIP

If your address has changed or if you are the new owner of the personal watercraft, be sure to notify BRP by either:

- mailing the card below;
- calling at (715) 848-4957 (USA) or (819) 566-3366 (Canada) or
- notifying an authorized Sea-Doo dealer.

In case of change of ownership, please join a proof that the former owner agreed to the transfer.

Notifying BRP, even after the expiration of the limited warranty, is very important as it enables BRP to reach the personal watercraft owner if necessary, like when safety recalls are initiated. It is the owner's responsibility to notify BRP of a change of address or owner.

STOLEN UNITS: If your personal watercraft is stolen, you should notify BRP or an authorized Sea-Doo dealer. We will ask you to provide your name, address, phone number, the hull identification number of your personal watercraft and the date it was stolen.



CHANGE OF ADDRESS <input type="checkbox"/>	CHANGE OF OWNERSHIP <input type="checkbox"/>	
WATERCRAFT IDENTIFICATION NUMBERS		
Model Number	Hull Identification Number (H.I.N.)	
OLD ADDRESS OR PREVIOUS OWNER:		
_____ NAME		
_____ NO.	_____ STREET	_____ APT
_____ CITY	_____ STATE/PROVINCE	_____ ZIP/POSTAL CODE
_____ COUNTRY		
NEW ADDRESS OR NEW OWNER:		
_____ NAME		
_____ NO.	_____ STREET	_____ APT
_____ CITY	_____ STATE/PROVINCE	_____ ZIP/POSTAL CODE
_____ COUNTRY		

F00A2ZL

AFFIX
PROPER
POSTAGE

**Bombardier
Recreational Products Inc.**

WARRANTY DEPARTMENT
75, J.A. Bombardier
Sherbrooke, QC
Canada
J1L 1W3

V00A2G

AFFIX
PROPER
POSTAGE

**Bombardier
Recreational Products Inc.**

WARRANTY DEPARTMENT
75, J.A. Bombardier
Sherbrooke, QC
Canada
J1L 1W3

V00A2G

WATERCRAFT MODEL No. _____

HULL IDENTIFICATION NUMBER (H.I.N.) _____

ENGINE IDENTIFICATION NUMBER (E.I.N.) _____

Owner: _____
NAME

No. STREET APT

CITY STATE/PROVINCE ZIP/POSTAL CODE

Purchase Date _____
YEAR MONTH DAY

Warranty Expiry Date _____
YEAR MONTH DAY

To be completed by the authorized Sea-Doo dealer at the time of the sale.

DEALER IMPRINT AREA

219 000 405

CA

OPERATOR'S GUIDE, 4-TEC SERIES / ENGLISH
GUIDE DU CONDUCTEUR, SÉRIE 4-TEC / ANGLAIS

FAIT AU / MADE IN CANADA

U/M.P.C.

©™ TRADEMARKS OF BOMBARDIER RECREATIONAL PRODUCTS INC. OR ITS AFFILIATES.

*TRADEMARK OF BOMBARDIER INC. USED UNDER LICENSE.

†TRADEMARK OF CASTROL LIMITED USED UNDER LICENSE.

©2005 BOMBARDIER RECREATIONAL PRODUCTS INC. ALL RIGHTS RESERVED. PRINTED IN CANADA.